

POOL A

1	GUSANO GONZALEZ, Aimar	NAV
17		
9	MOROSO GOMEZ, Fernando	CTB
25	PEREZ DIAZ, Brandon	MAD
5	CHAVEZ MENDOZA, Sergio	CAN
21	OUAJDANE SANCHEZ, Isaac	VAL
13	ROYO PUCLESEANU, Eros	ARA
29	CARBALLO ZAKARYA, Pablo	EXT

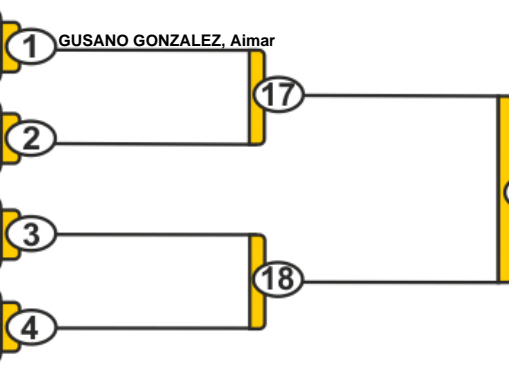

POOL B

3	MARTINEZ CALATRAVA, Iker	CAT
19		
11	DE LA TORRE LOIZAGA, Oier	VAS
27	GARCIA GALDO, Yago	GAL
7	PORRERO CURIEL, Marcos	CLE
23		
15	LANZAT ALBADALEJO, Ignacio	MAD
31	AGUILI, Anas	MUR

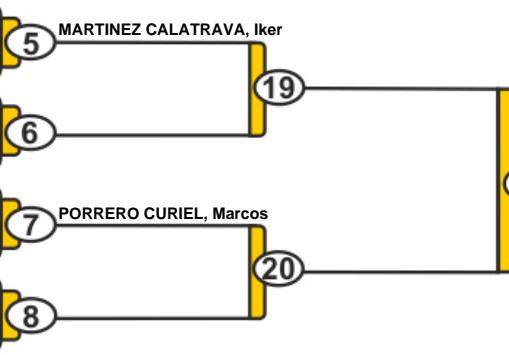

POOL C

2	MIRANDA GALINDO, Eduardo	ARA
18		
10	FERNANDEZ ESCANO, Marcos	AST
26	OBREGON MUNOZ, Samuel	RIO
6	MARQUEZ ORTEGA, Isaac	CAT
22	GIRONES ARTAZCOZ, Inigo	NAV
14	ROJAS DE LA ROSA, Alexis	AND
30	SAN ROMAN SAEZ BRAVO, Sergio	MAD

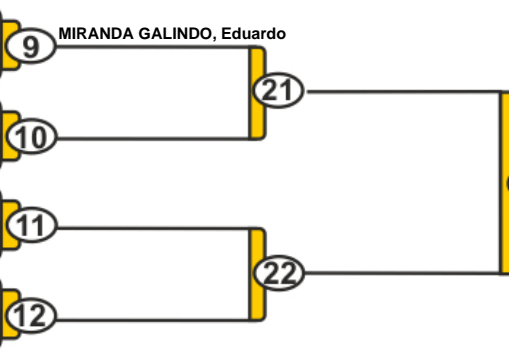

POOL D

4	CUADROS RUIZ, Hugo	VAL
20		
12	LARRAMENDI BALLADARES, Tiago	GAL
28	MORENO SERRANO, Jaime	CLM
8	ROLDAN JIMENEZ, Victor	VAL
24		
16	SERRA EGEEA, Guillem	BAL
32	QUINTERO IGLESIAS, Samuel	MAD

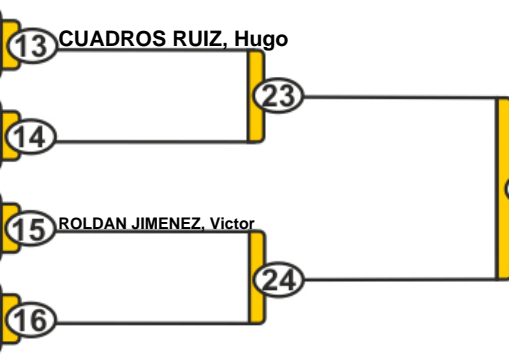

1.

43



Results

Résultat / Platzierungen / Resultados

1.
2.
3.
4.
5.
6.
7.

Trostrunde / Repechage / Ronda de consolación

Repechage / Trostrunde / Repechage

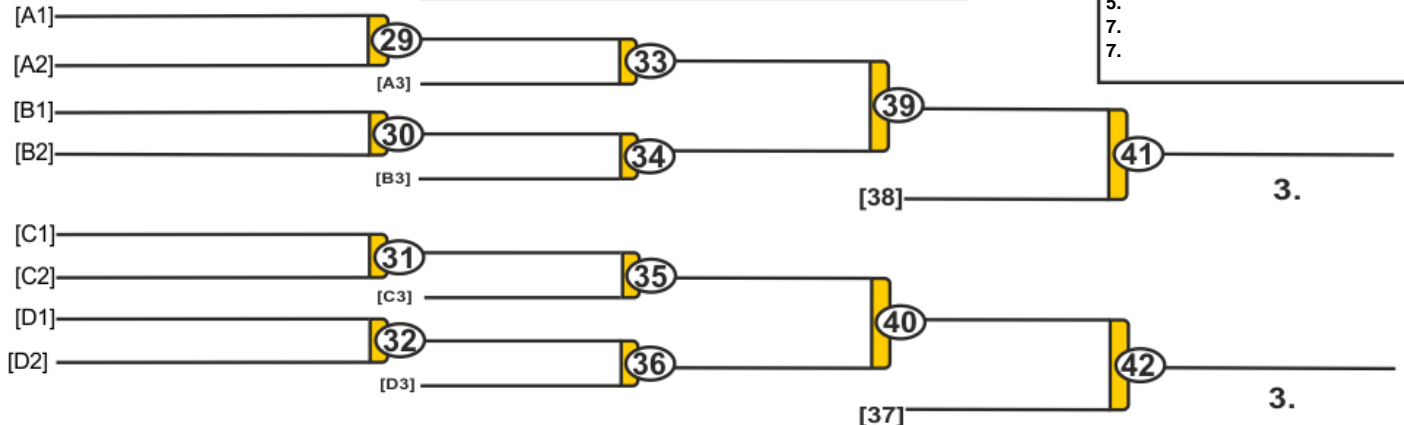

POOL A

1	MORALES CABALLERO, Eric Juan	CAN	1	MORALES CABALLERO, Eric Juan
17			17	
9	ALCAZAR CRESPO, Manuel	EXT	2	
25	PEREZ ROLDAN, Jaime	AND	25	
5	OTAZU GARRIDO, Cesar	NAV	3	
21	FLORES RIPALDA, Jose Antonio	MAD	18	
13	SALA CATUNDA, Gabriel	BAL	4	
29	LISEITEV, Vasilii	CAT	18	

POOL B

3	MARI ALMIRA, Ismael	VAL	5	MARI ALMIRA, Ismael
19			19	
11	PEREZ PRADO, Diego	AST	6	
27	RODRIGUEZ PASCUAL, Ivan	CLE	26	
7	LEμος TOLEDO, Joao Vitor	MAD	7	LEμος TOLEDO, Joao Vitor
23			20	
15	LOPEZ VEGA, Endika	VAS	8	
31	CARRERA PEREZ, Alejandro	RIO	20	

POOL C

2	CUEVAS FERRI, Daniel	VAL	9	CUEVAS FERRI, Daniel
18			21	
10	SUAREZ OCANDO, Francisco Javier	CAN	10	
26	CARAZO LACUNZA, Julio	MAD	27	
6	SEMPERE GALINDO, Elias	VAL	11	
22	GONZALEZ HERNANDEZ, Jose David	MUR	22	
14	AYENSA ELIZALDE, Aritz	NAV	12	
30	RODRIGO CALVO, Adrian	ARA	22	

POOL D

4	GONZALEZ ARTIME, Mikel	AST	13	GONZALEZ ARTIME, Mikel
20			23	
12	TATO FERNANDEZ, Samuel	GAL	14	
28	VAZQUEZ SANCHEZ, Adrian	MAD	28	
8	LAMAS BALTASAR, Jorge	CTB	15	LAMAS BALTASAR, Jorge
24			24	
16	VERGARA CARRILERO, Sergio	CLM	16	
32	BELAID KOHOUS, Ismahil	MEL	24	

Repechage

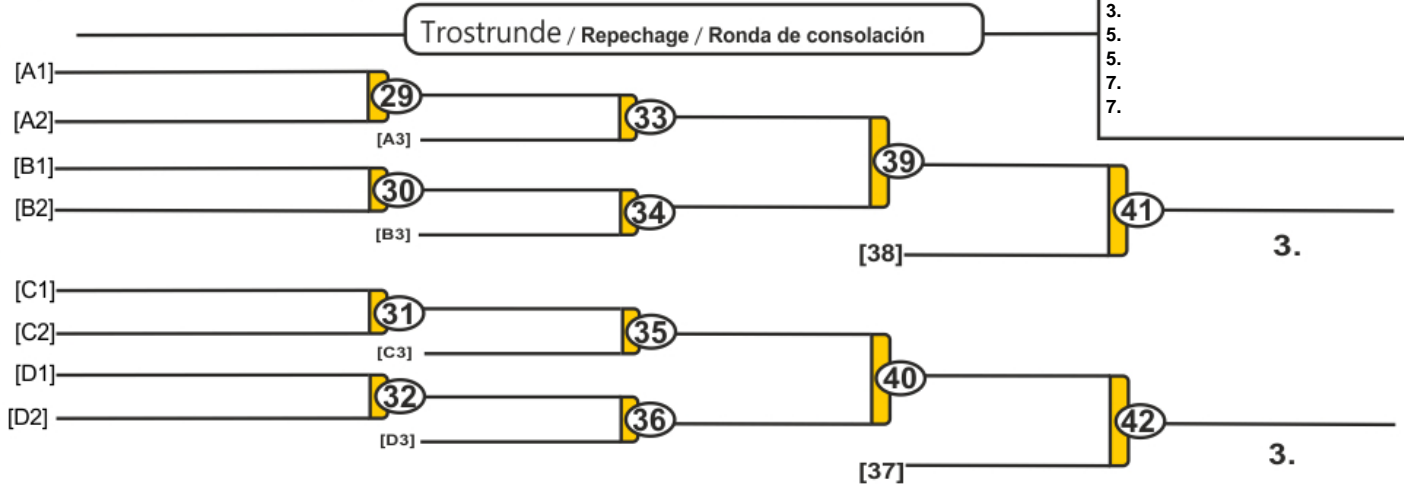

1.

43



Results	
Résultat / Platzierungen / Resultados	
1.	
2.	
3.	
3.	
5.	
5.	
7.	
7.	

POOL A

1	MIER AROCO, David	MAD	1	MIER AROCO, David
17			17	
9	CHIRILA MARIN, Cristian	CLM	2	
25	SANCHEZ RUBIN, Javier	GAL	2	
5	HIDALGO CLAUSIN, Alex	CAT	3	HIDALGO CLAUSIN, Alex
21			18	
13	ALONSO ALVAREZ, Mario	CLE	4	
29	CASTANO PLOMER, Adrian	BAL	4	

POOL B

3	LAZARO MOLINA, Hector	MAD	5	LAZARO MOLINA, Hector
19			19	
11	NUNEZ MOLINA, Juan Antonio	CAN	6	
27	ECHANIZ RIOS, Hegoi	VAS	6	
7	FUERTES AYALA, Raul	RIO	7	FUERTES AYALA, Raul
23			20	
15	RODRIGUEZ BURGUILLO, Izan	MAD	8	
31	ORTEGA ALMUNIA, Oscar	ARA	8	

POOL C

2	EL ARJOUNI GOMEZ, Saif Eddine	BAL	9	EL ARJOUNI GOMEZ, Saif Eddine
18			21	
10	KOPNYAYEV, Ignat	MUR	10	
26	MARZOK MOHAMED, Ilias	MEL	10	
6	FERNANDEZ DONAIRE, Gonzalo	AST	11	FERNANDEZ DONAIRE, Gonzalo
22			22	
14	BUDIA CRIADO, Roman	MAD	12	
30	MARIN FERNANDEZ, Pablo	EXT	12	

POOL D

4	PARRILLA MUNOZ, Daniel	GAL	13	PARRILLA MUNOZ, Daniel
20			23	
12	EXPOSITO GONZALEZ, Cesar	CTB	14	
28	CANUT RUANO, Jorge	VAL	14	
8	GUTIERREZ ASENSIO, Jorge	MAD	15	GUTIERREZ ASENSIO, Jorge
24			24	
16	RUBIO IGLESIAS, Rafael	AND	16	
32	ARRIBAS GUTIERREZ, Aitor	NAV	16	

POOL A Winner / Ganador
Vainqueur / Sieger

POOL B Winner / Ganador
Vainqueur / Sieger

POOL C Winner / Ganador
Vainqueur / Sieger

POOL D Winner / Ganador
Vainqueur / Sieger



1.

43

38

28

Results

Résultat / Platzierungen / Resultados

1.
2.
3.
3.
5.
5.
7.
7.

Trostrunde / Repechage / Ronda de consolación

Repechage / Trostrunde / Repechage

[A1]	29	33	
[A2]			
[B1]		[A3]	39
[B2]	30	34	41
		[B3]	[38]
[C1]			
[C2]	31	35	
[D1]		[C3]	40
[D2]	32	36	42
		[D3]	[37]

3.

3.

POOL A

1	COTON VAZQUEZ, Anderson Dibar	GAL	1	COTON VAZQUEZ, Anderson Dibar
17			17	
9	PIZARRO CASAS, Carlos	MAD	2	
25	HURTADO MOLINA, Nauzet	CAN	25	
5	CASADO OLAYA, Joan	CAT	3	
21	BAZTAN MERCHAN, Inaki	EXT	18	
13	GARCIA CASTRO, Jaime	AND	4	
29	PEREZ PELLON, Javier	AST	4	

POOL A Winner / Ganador
Vainqueur / Sieger

POOL B

3	TERES CEREZA, Hugo	ARA	5	TERES CEREZA, Hugo
19			19	
11	GALVEZ MARIBLANCA, Manuel	CLM	6	
27	JORDA ALVENTOSA, Javier	VAL	7	
7	SANUDO SAMPERIO, Marco	CTB	7	SANUDO SAMPERIO, Marco
23			20	
15	PEREZ CANTALEJO, Hector	MAD	8	
31	BERTO JORGE, Hugo	GAL	8	

POOL B Winner / Ganador
Vainqueur / Sieger

POOL C

2	TOCINO RUIZ, Lucas	GAL	9	TOCINO RUIZ, Lucas
18			21	
10	BADA ALCONCHEL, Miguel	NAV	10	
26	LOZINSKY VILLORIA, Nicolas	CLE	11	
6	TAFALLA BROTO, Mariano	ARA	11	TAFALLA BROTO, Mariano
22			22	
14	CASTELLANOS MORERA, Ruben	MAD	12	
30	GALLARDO LLINAS, Joan Toni	BAL	12	

POOL C Winner / Ganador
Vainqueur / Sieger

POOL D

4	MONTERO ALVAREZ, Nicolas	GAL	13	MONTERO ALVAREZ, Nicolas
20			23	
12	AHMED MAHMOUD DOKMAK, Yusef	VAS	14	
28	SERRANO PARTIDO, Alejandro	MAD	15	
8	NAVARIDAS MARTIN, Simon	RIO	15	NAVARIDAS MARTIN, Simon
24			24	
16	LUCAS CAMPOS, Miguel	MUR	16	
32	LOZANO LOPEZ, Gabriel	CLM	16	

POOL D Winner / Ganador
Vainqueur / Sieger

1.

43



38

Results

Résultat / Platzierungen / Resultados

1.
2.
3.
4.
5.
6.
7.

Trostrunde / Repechage / Ronda de consolación

Repechage / Trostrunde / Repechage

[A1]	29	[A2]	33	[A3]		
[B1]	30	[B2]	34	[B3]		39
[C1]	31	[C2]	35	[C3]		38
[D1]	32	[D2]	36	[D3]		40
						41
						42

3.

3.

POOL A

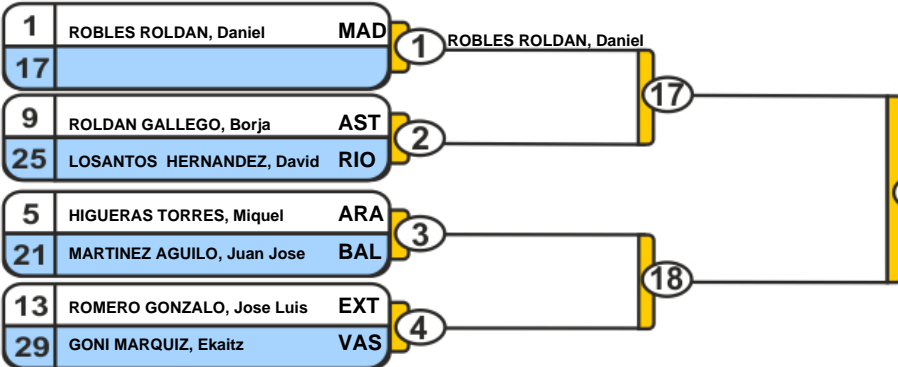

POOL A Winner / Ganador
Vainqueur / Sieger

POOL B

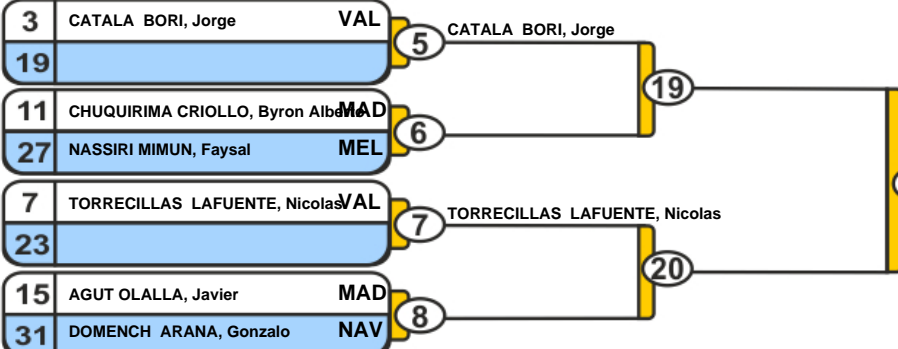

POOL B Winner / Ganador
Vainqueur / Sieger

POOL C

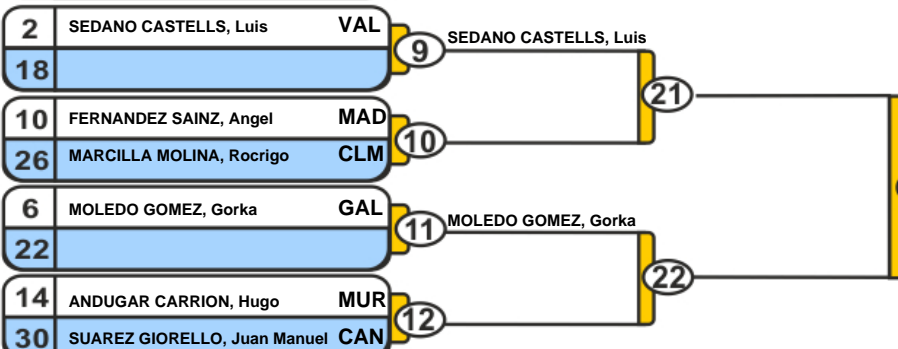

POOL C Winner / Ganador
Vainqueur / Sieger

POOL D

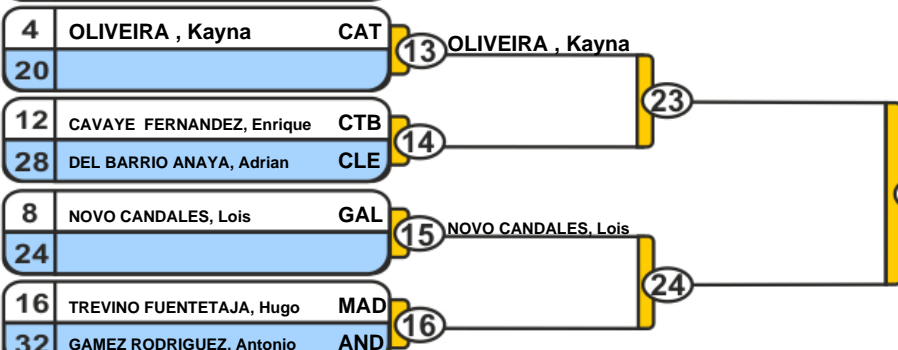

POOL D Winner / Ganador
Vainqueur / Sieger

1.

43



Results	
Résultat / Platzierungen / Resultados	
1.	
2.	
3.	
3.	
5.	
5.	
7.	
7.	

Trostrunde / Repechage / Ronda de consolación

Repechage / Trostrunde / Repechage

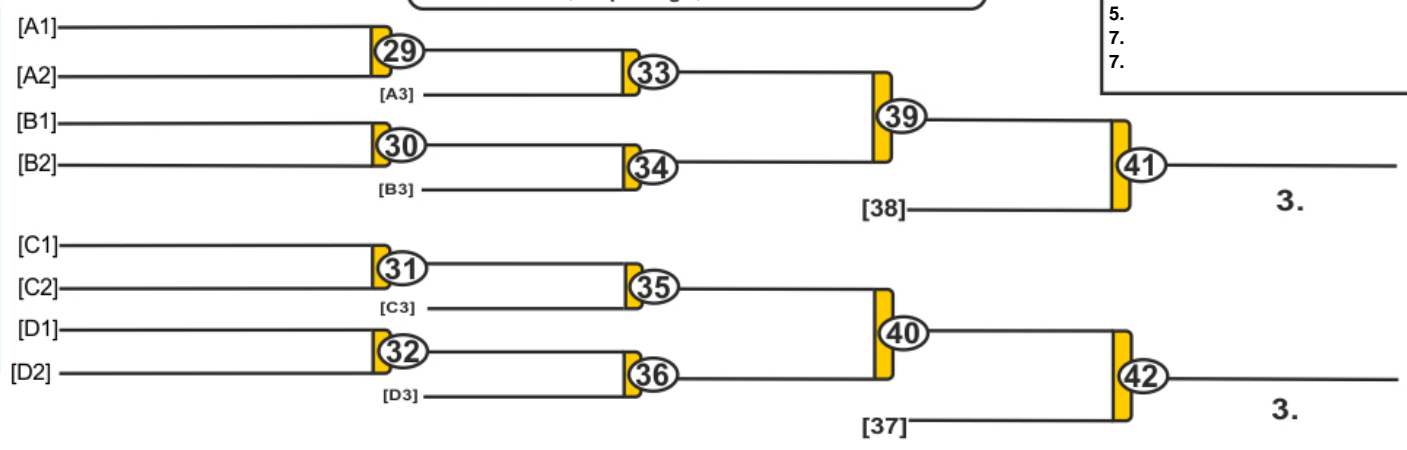

3.

3.

POOL A

1	PLESA , Iulian Gabriel	CAN
17		
9	PINEDA ASTUDILLO, Frank Davis	CAT
25	MOLINA BANOS, Samuel	RIO
5	SANCHEZ TENA, Mario	ARA
21	ZARCO PEINADO, Rodrigo	CLM
13	MUNOZ SANTOS, Sergio	VAS
29	RIOS MARTINEZ, Aitor	MAD

1 PLESA , Iulian Gabriel

17

2

3

4

25

POOL A Winner / Ganador
Vainqueur / Sieger

37

POOL B

3	MARQUES CRESPO, Gutier	GAL
19		
11	AL LAL HAMIDA, Hamza	MEL
27	VIVES ESTELRICH, Marc	BAL
7	LYSENKO , Daniel	VAL
23		
15	TIMUAT PANGILINAN ENRIQUEZ, RMA	MAD
31	GOMEZ MORALES, Jorge	AND

5 MARQUES CRESPO, Gutier

19

6

7 LYSENKO , Daniel

20

8

26

POOL B Winner / Ganador
Vainqueur / Sieger

43

POOL C

2	GADEA JUAN, Borja	VAL
18		
10	OTERO HERRERO, Juan	CTB
26	BELOV , Sergey	CAN
6	ENERIZ GARCIA, Arkaitz	NAV
22	DEL VAL MARTIN, Angel	CLE
14	RUIZ CARRACEDO, Inaki	MAD
30	SANTEODORO CUEVAS, Angel	EXT

9 GADEA JUAN, Borja

21

10

11

12

27

POOL C Winner / Ganador
Vainqueur / Sieger

38

POOL D

4	GARCIA ANTON, Merlin	VAL
20		
12	GONZALEZ BLANCO, Ivan	AST
28	BLANCO SANCHEZ, Hugo	CAT
8	FERNANDEZ BOU, Carlos	VAL
24	GOREA , Vlad	MAD
16	RODRIGUEZ DOMINGUEZ, Javier	AND
32	NIETO ESCUDERO, Ignacio	MUR

13 GARCIA ANTON, Merlin

23

14

15

16

28

POOL D Winner / Ganador
Vainqueur / Sieger



Results

Résultat / Platzierungen / Resultados

1.
2.
3.
3.
5.
5.
7.
7.

Trostrunde / Repechage / Ronda de consolación

Repechage / Trostrunde / Repechage

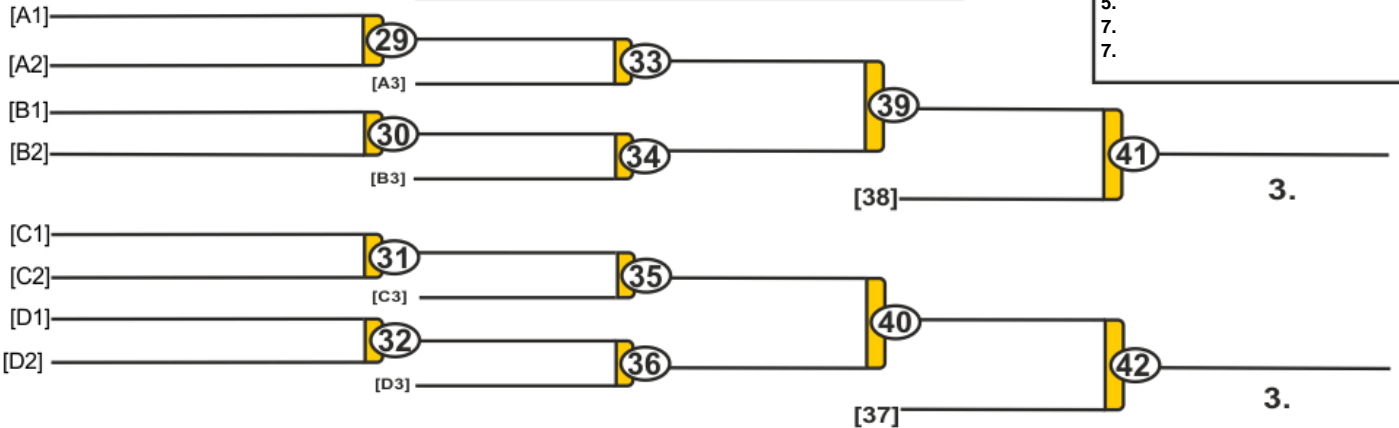

POOL A

1	ARACIL MARTINEZ, Luis	VAL
17		
9	CASASOLA SOLAR, Diego	MAD
25	GARCIA KHOLODOV, Maximo	ARA
5	TIGERAS MIRETE, Eduardo	MUR
21		
13	VIRALTA MINANA, Ignasi	CAT
29	JAUREGI TEJADA, Ander	VAS

1	ARACIL MARTINEZ, Luis
17	
2	
3	TIGERAS MIRETE, Eduardo
18	
4	

POOL A Winner / Ganador
Vainqueur / Sieger

POOL B

3	PAJARES FERNANDEZ, Oscar	RIO
19		
11	GONZALEZ GONZALEZ, Tanausu	CAN
27	RODRIGUEZ RAYON, Alvaro	AST
7	PENALVER GRAO, Ademar	VAL
23		
15	SANCHEZ DEL RIO, Diego	CLE
31	BANDERAS GIL, David	MAD

5	PAJARES FERNANDEZ, Oscar
19	
6	
7	PENALVER GRAO, Ademar
20	
8	

POOL B Winner / Ganador
Vainqueur / Sieger

POOL C

2	SANCHEZ PASTOR, Ernesto	MAD
18		
10	ARAMBEL FERNANDEZ, Ivan	NAV
26	DRIS EL OUTMANI, Salehdin	MEL
6	VERGARA MARTIN, Ivan	MAD
22		
14	CRESPI JUAN, Marc	BAL
30	MURILLO CORTES, Justo	CLM

9	SANCHEZ PASTOR, Ernesto
21	
10	
11	VERGARA MARTIN, Ivan
22	
12	

POOL C Winner / Ganador
Vainqueur / Sieger

POOL D

4	LLORENS ORTIZ, Marc	CAT
20		
12	DOMINGUEZ LOPEZ, Juan	AND
28	PARDO RODRIGUEZ, Pablo	EXT
8	SANTOS MATO, Sergio	GAL
24		
16	PEREZ PEREZ, Unai	MAD
32	SAIZ MOVELLAN, Alberto	CTB

13	LLORENS ORTIZ, Marc
23	
14	
15	SANTOS MATO, Sergio
24	
16	

POOL D Winner / Ganador
Vainqueur / Sieger

1.

43



Results	
Résultat / Platzierungen / Resultados	
1.	
2.	
3.	
3.	
5.	
5.	
7.	
7.	

Trostrunde / Repechage / Ronda de consolación

Repechage / Trostrunde / Repechage

[A1]		29	
[A2]			33
[B1]			
[B2]		30	
			34
[C1]			
[C2]		31	
[D1]			
[D2]		32	
			36

[A3]			
[B3]			
[C3]			
[D3]			

[38]

3.

[37]

3.

POOL A

1	TORRES HERNANDEZ, Enrique	AST	1	TORRES HERNANDEZ, Enrique
17			17	
9	FERNANDEZ BLANCO, Francisco	MAD	2	
25	RUIZ ULACIA, Alberto	RIO	25	
5	BLANCO ARMENTEROS, Jose Manuel	EXT	3	BLANCO ARMENTEROS, Jose Manuel
21			18	
13	VILES BARRENA, Diego	VAS	4	
29	RUBIO ALCONCHEL, Valentin	ARA	29	

POOL A Winner / Ganador
Vainqueur / Sieger

POOL B

3	DUBREUIL GALVAN, Angel	CAN	5	DUBREUIL GALVAN, Angel
19			19	
11	SOPELANA LORENZO, Daniel	NAV	6	
27	GOMEZ YUGUEROS, Diego	CLE	27	
7	GARCIA ROJAS, Rodrigo	MAD	7	GARCIA ROJAS, Rodrigo
23			20	
15	KEVLISHVILI, Davit	AND	8	
31	FERNANDEZ HERNANDEZ, Pedro	CAN	31	

POOL B Winner / Ganador
Vainqueur / Sieger

POOL C

2	LABADO RETA, Joseba	NAV	9	LABADO RETA, Joseba
18			21	
10	BADANIN, Artem	CAT	10	
26	JIMENEZ MOYA, Alejandro	MAD	26	
6	SALGADO LAGO, Alberto	GAL	11	SALGADO LAGO, Alberto
22			22	
14	GARRIDO OLMOS, Santiago	MUR	12	
30	CASTRO GONZALEZ, Raul	CAN	30	

POOL C Winner / Ganador
Vainqueur / Sieger

POOL D

4	SAUMELL SOLANO, Ruben	VAL	13	SAUMELL SOLANO, Ruben
20			23	
12	CUESTA MENENDEZ, Bruno	AST	14	
28	GONZALEZ LLATA, Asier	CTB	28	
8	CALDERON LASO, Pablo	VAL	15	CALDERON LASO, Pablo
24			24	
16	ADRIAN BRAD, David	MAD	16	
32	BUENO CASTELLANO, Sergi	BAL	32	

POOL D Winner / Ganador
Vainqueur / Sieger

1.

43



Results	
Résultat / Platzierungen / Resultados	
1.	
2.	
3.	
4.	
5.	
6.	
7.	

Trostrunde / Repechage / Ronda de consolación



POOL A

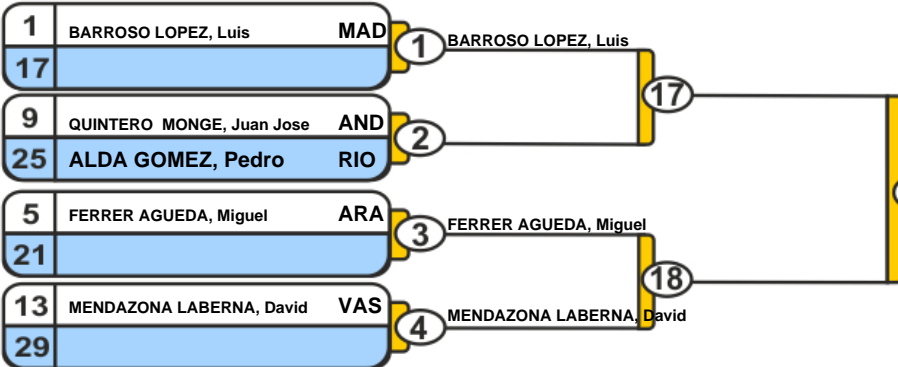

POOL A Winner / Ganador
Vainqueur / Sieger

POOL B

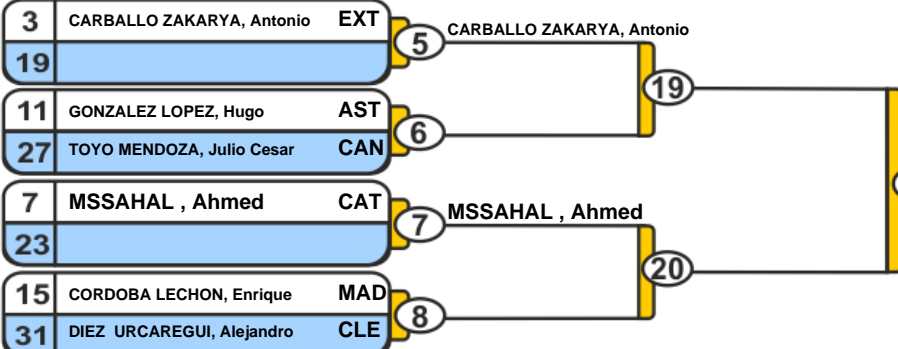

POOL B Winner / Ganador
Vainqueur / Sieger

POOL C

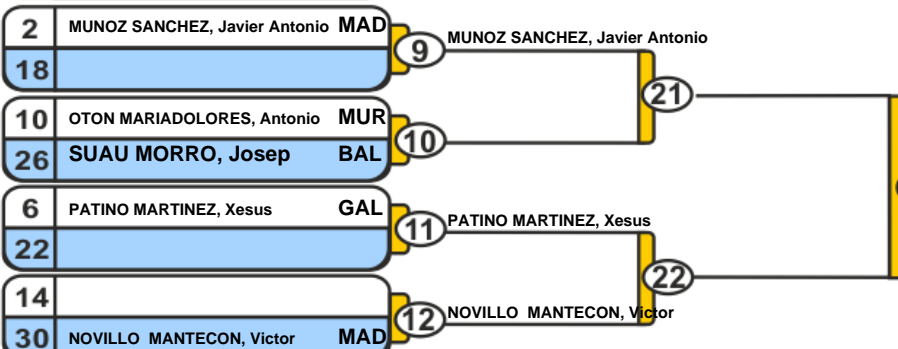

POOL C Winner / Ganador
Vainqueur / Sieger

POOL D

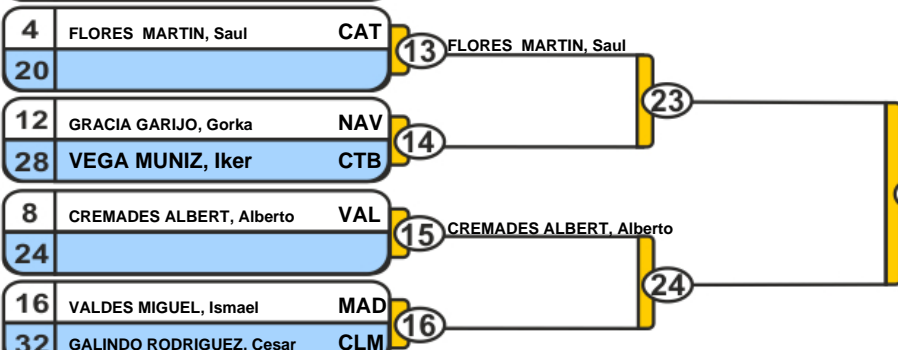

POOL D Winner / Ganador
Vainqueur / Sieger

1.

43



Results	
Résultat / Platzierungen / Resultados	
1.	
2.	
3.	
3.	
5.	
5.	
7.	
7.	

Trostrunde / Repechage / Ronda de consolación

Repechage / Trostrunde / Repechage

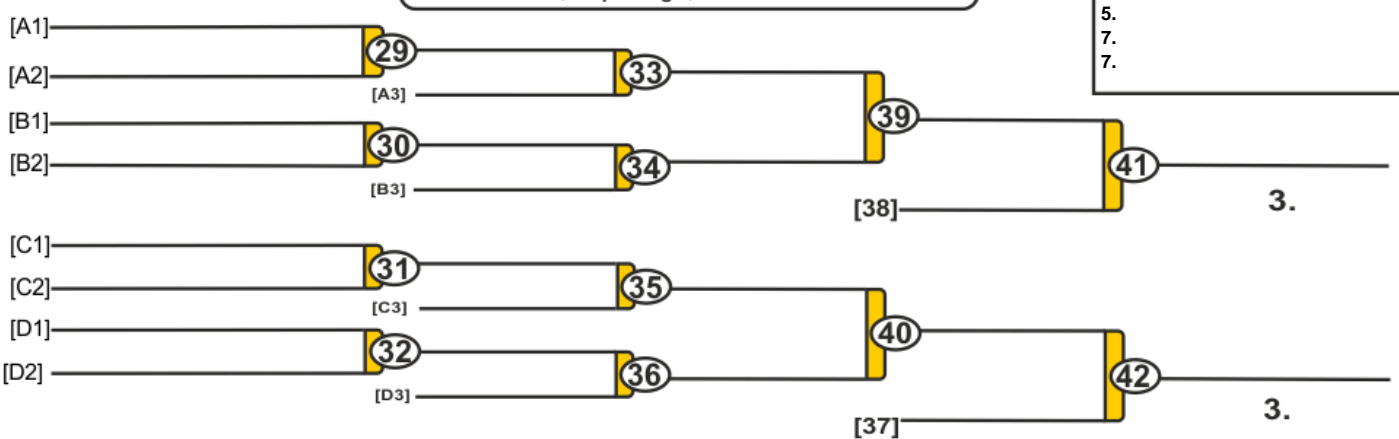

3.

3.

POOL A

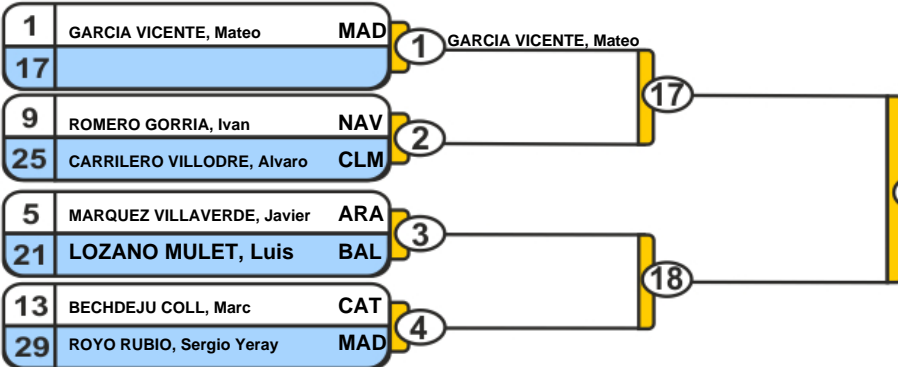

POOL A Winner / Ganador
Vainqueur / Sieger

POOL B

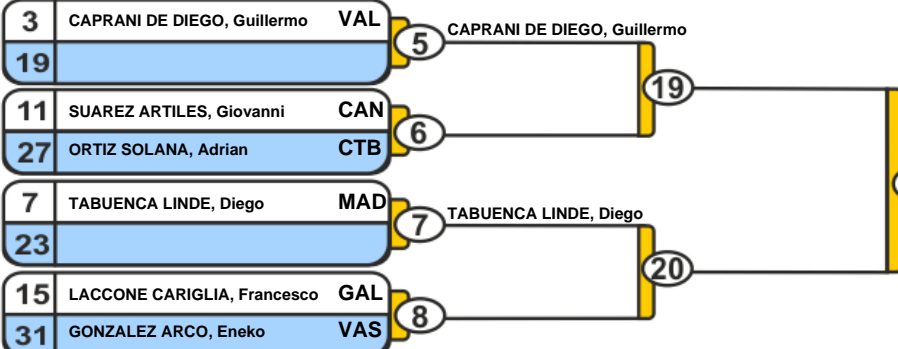

POOL B Winner / Ganador
Vainqueur / Sieger

POOL C

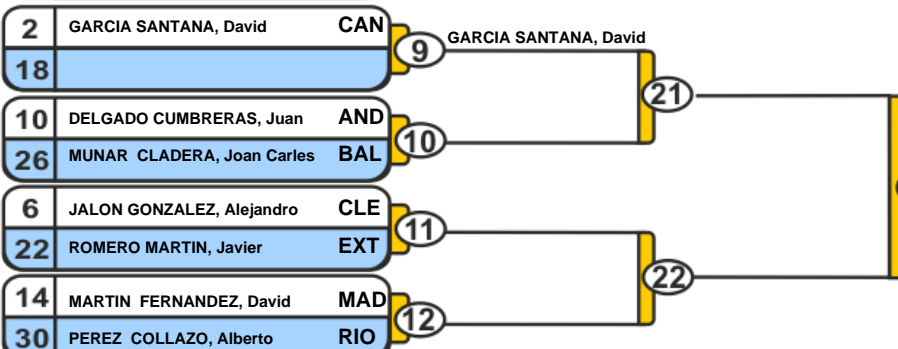

POOL C Winner / Ganador
Vainqueur / Sieger

POOL D

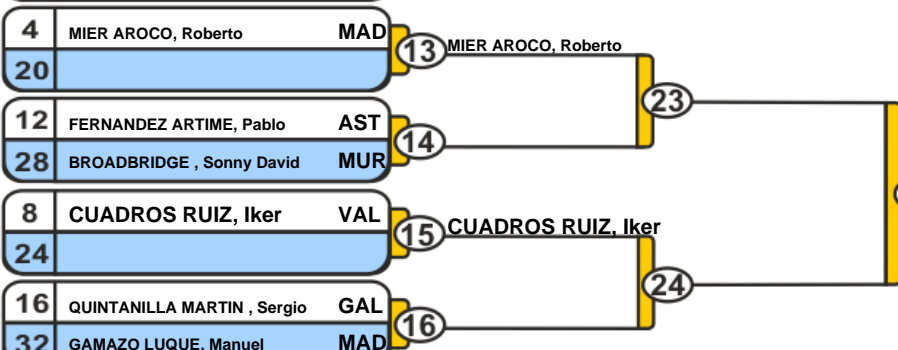

POOL D Winner / Ganador
Vainqueur / Sieger

1.

43



Results	
Résultat / Platzierungen / Resultados	
1.	
2.	
3.	
3.	
5.	
5.	
7.	
7.	

Trostrunde / Repechage / Ronda de consolación



3.

3.

POOL A

1	CORRAL GARRIDO, Javier	AST	1	CORRAL GARRIDO, Javier
17			17	
9	LUBIAN GOMEZ, Pablo	AND	2	
25	MIRANDA ALONSO, Raul	CAN	25	
5	GIMENO TRICOT, David	VAL	3	
21	BERNAL AIELLO, Alvaro	MAD	18	
13	ROSAS SOLANO, Alejandro	ARA	4	
29	LOPEZ AGUADO, Marcos	CTB	4	

POOL A Winner / Ganador
Vainqueur / Sieger

POOL B

3	TAMARGO ALVAREZ, Borja	AST	5	TAMARGO ALVAREZ, Borja
19			19	
11	MARTIN GOMEZ, Asier	CLE	6	
27	LLULL RIERA, Lluís	BAL	6	
7	GAMERO IBARRA, Alberto	EXT	7	GAMERO IBARRA, Alberto
23			20	
15	BERROCAL CABALLERO, Alberto	MAD	8	
31	MARTIN GONZALEZ, Alex	CAT	8	

POOL B Winner / Ganador
Vainqueur / Sieger

POOL C

2	VERA HENKEL, Fabio Tim	BAL	9	VERA HENKEL, Fabio Tim
18			21	
10	TOBARRA TEBAR, Tomas	CLM	10	
26	DRIS EL OUTMANI, Wasim	MEL	10	
6	VERGARA DOMINGUEZ, Sergio	NAV	11	
22	PANIZO GUTIERREZ, Ignacio	MAD	11	
14	PAJARES FERNANDEZ, Alejandro	RIO	12	
30	HARINA GARTZIA, Hodei	VAS	12	

POOL C Winner / Ganador
Vainqueur / Sieger

POOL D

4	GONZALEZ CASTEJON, Ivan	ARA	13	GONZALEZ CASTEJON, Ivan
20			23	
12	CASTRO ESTEBAN, Diego	MAD	14	
28	STOYKOV, Martin	CAT	14	
8	GARCIA MONTERO, Alfonso	GAL	15	GARCIA MONTERO, Alfonso
24			24	
16	JIMENEZ GAGO, Rafael	AND	16	
32	MARTINEZ GIMENEZ, Nicolas	MUR	16	

POOL D Winner / Ganador
Vainqueur / Sieger

1.

43



Results

Résultat / Platzierungen / Resultados

1.
2.
3.
3.
5.
5.
7.
7.

Trostrunde / Repechage / Ronda de consolación

Repechage / Trostrunde / Repechage

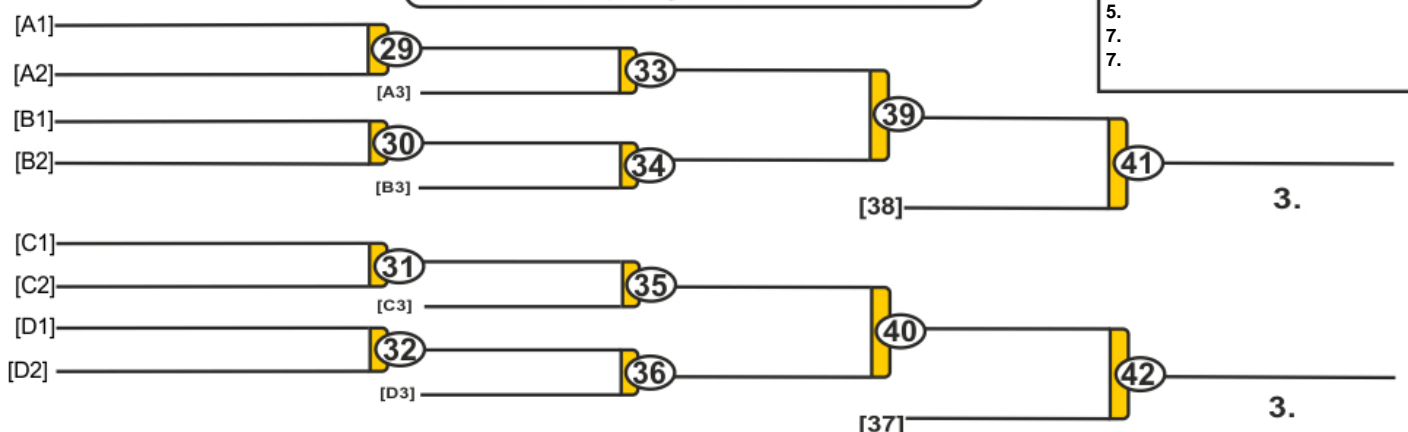

3.

3.

POOL A

1	MERINO MENCIA, Unai	VAS
17		
9	CARO PINTO, Marco Antonio	AND
25	HERRERA MOLINA, Hector	MAD
5	ABEJON PEREZ, Alberto	AST
21	MARTINEZ SAEZ, Mario	EXT
13	ARANA RODRIGUEZ, Oier	NAV
29	PEREZ BARRIOS, Dario	MAD

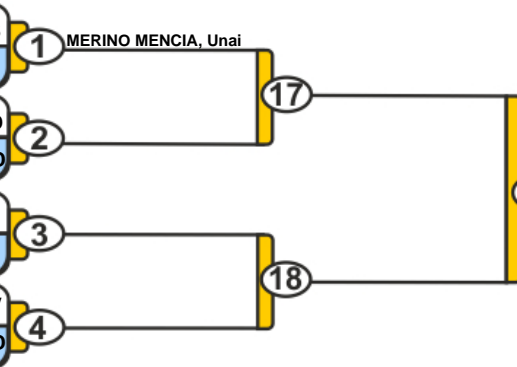

POOL A Winner / Ganador
Vainqueur / Sieger

POOL B

3	OBREGON MUNOZ, Felix	RIO
19	LORENZO RAMOS, Adrian	CLM
11	ALONSO GARCIA, Alvaro	CLE
27	MORALES MONTERO, Christian	GAL
7	BUENO INFANTES, Carlos	VAL
23	NAVARRO PEREZ, Alejandro	MAD
15	HERNANDEZ PEREZ, Xerach	CAN
31	ESCRIVA PEREZ CHUECOS, Gabriel	BAL

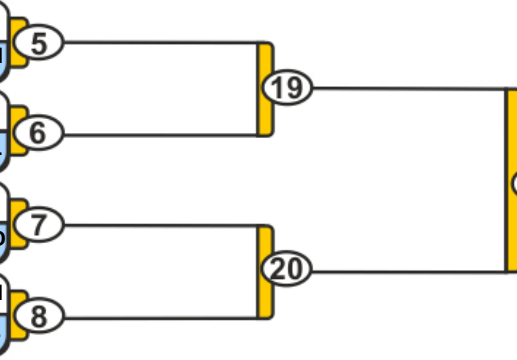

POOL B Winner / Ganador
Vainqueur / Sieger

POOL C

2	FLETA BERAZA, Jorge	VAS
18		
10	MONTSEIRIN COLLAR, David	AST
26	TABOADELA BLANCO, Adrian	MAD
6	SANTAS COLOMER, Juan	VAL
22	QUINTIN OTEIZA, Jorge	RIO
14	GARCIA RODRIGUEZ, Yeray	CTB
30	DORADO PUENTE, Juan Francisco	MAD

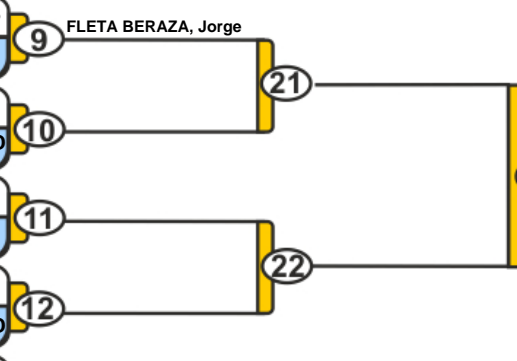

POOL C Winner / Ganador
Vainqueur / Sieger

POOL D

4	PENA INSAUSTI, Juan	MAD
20	PEREZ AGUEDA, Rodrigo	ARA
12	LEON ONECA, Igor	NAV
28	HERNANDEZ MARTINEZ, Miguel	CAT
8	CARRERA GARRIDO, Zigor	RIO
24	MOHAMEDI MOHAND, Fuad	MEL
16	FERNANDEZ GARCIA, Pedro Jose	MUR
32	PINA RODRIGUEZ, Maximo	GAL

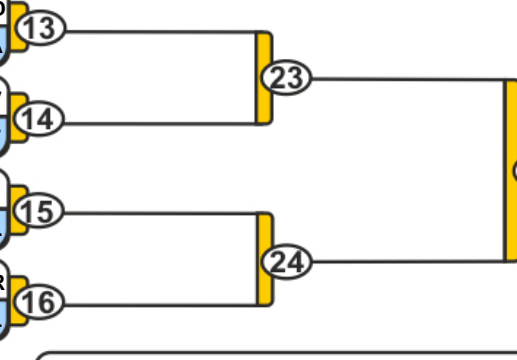

POOL D Winner / Ganador
Vainqueur / Sieger

1.

43



Results	
Résultat / Platzierungen / Resultados	
1.	
2.	
3.	
3.	
5.	
5.	
7.	
7.	

Trostrunde / Repechage / Ronda de consolación

Repechage / Trostrunde / Repechage

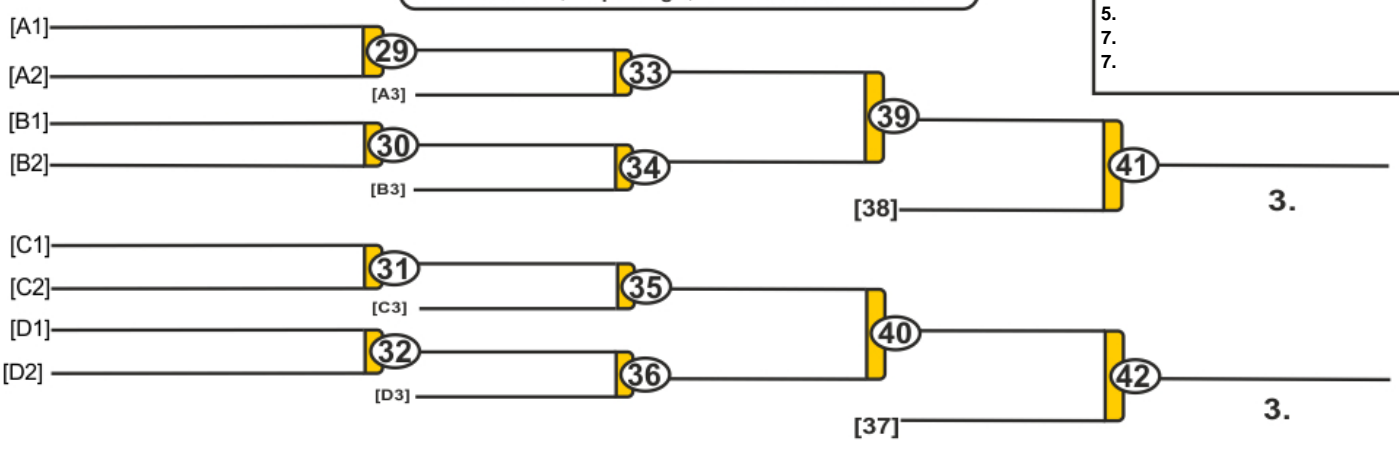

POOL A

1	SOLIS MERE, Mateo	AST	1	SOLIS MERE, Mateo
17				17
9	DIAZ CABALLERO, David	CTB	2	
25	RECIO SANCHEZ, Pablo	CLE		25
5	CANO MARTOS, Alvaro	AND	3	
21	LOPEZ ROMAN, Xabat	VAS		18
13	GARCIA RIVILLA, Alejandro	MAD	4	
29	ANGUIANO LOPEZ, Jesus	EXT		18

POOL A Winner / Ganador
Vainqueur / Sieger

POOL B

3	BETANCOR DIAZ, Lionel	CAN	5	BETANCOR DIAZ, Lionel
19				19
11	CEBRIAN GUIRAO, Julio	CLM	6	
27	RUEDA TAGLE, Victor	MAD		19
7	BA , Kindi	CAT	7	BA , Kindi
23				20
15	OGAYAR SANCHEZ, Emilio	MUR	8	
31	BERTOMEU PEREZ, Roberto	VAL		20

POOL B Winner / Ganador
Vainqueur / Sieger

POOL C

2	ESTEVE MARIN, Jose Miguel	MUR	9	ESTEVE MARIN, Jose Miguel
18				21
10	THOMAS RIVAS, Alex	MAD	10	
26	BENAISA KOHOUS, Ayyub	MEL		21
6	DANELIA , Saba	VAS	11	
22	CARRION PEDRO , Santiago	VAL		22
14	MONTANER MARTIN , Jaime	ARA	12	
30	HERNANDEZ MARTINEZ, Jose	CAT		22

POOL C Winner / Ganador
Vainqueur / Sieger

POOL D

4	SAIZ MUNIZ, Pablo	CTB	13	SAIZ MUNIZ, Pablo
20				23
12	PLANES BERNAGAUD, Henri	NAV	14	
28	ALVAREZ LOMBA, Iago	GAL		23
8	ROLDAN BELTRAN, Sergio	MAD	15	
24	CARDONA ORTIZ , Alejandro	RIO		24
16	SANGIL SERRANO, Pablo	BAL	16	
32	SUAREZ GIORELLO, Felipe	CAN		24

POOL D Winner / Ganador
Vainqueur / Sieger

1.

43



Results

Résultat / Platzierungen / Resultados

1.
2.
3.
3.
5.
5.
7.
7.

Trostrunde / Repechage / Ronda de consolación

Repechage / Trostrunde / Repechage

[A1]	29	33	
[A2]			
[B1]	30	34	39
[B2]			
[C1]	31	35	
[C2]			
[D1]	32	36	40
[D2]			
			41
			42

3.

3.

POOL A

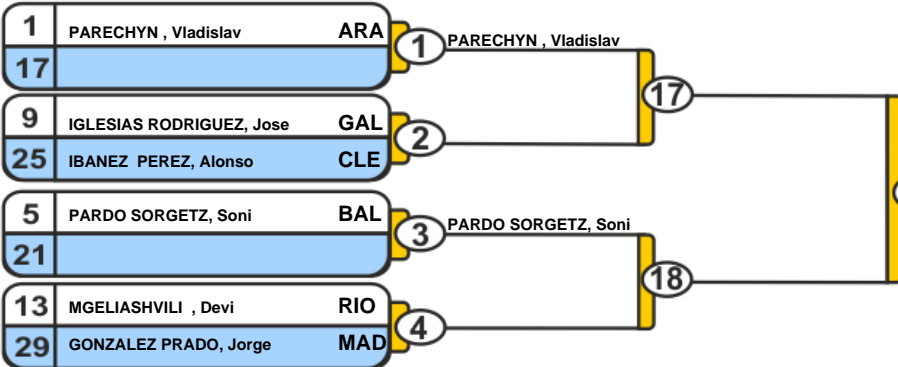

POOL A Winner / Ganador
Vainqueur / Sieger

POOL B

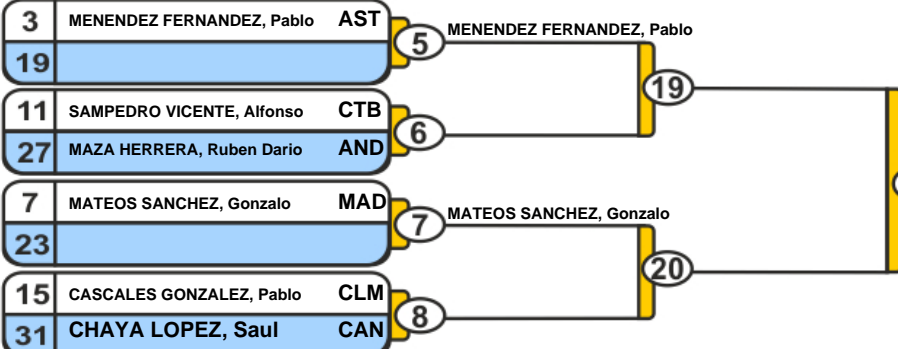

POOL B Winner / Ganador
Vainqueur / Sieger

POOL C

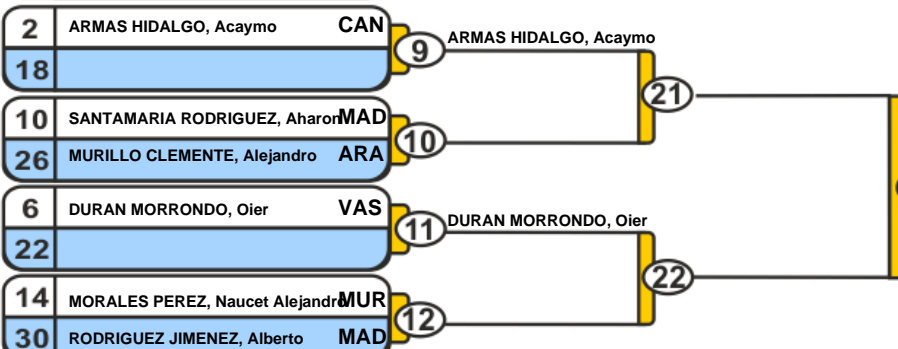

POOL C Winner / Ganador
Vainqueur / Sieger

POOL D

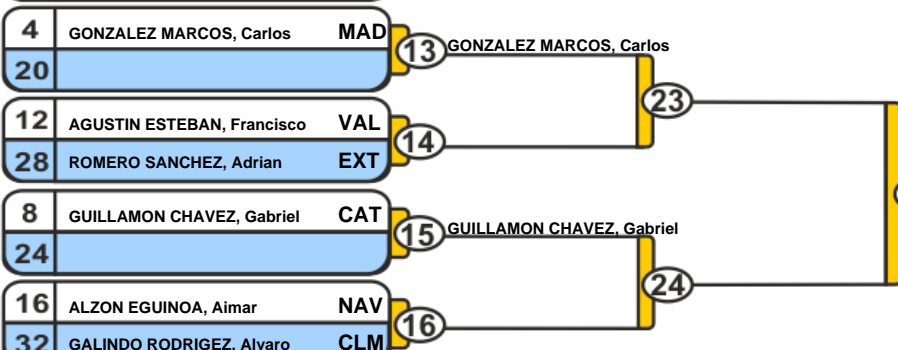

POOL D Winner / Ganador
Vainqueur / Sieger

1.

43



Results

Résultat / Platzierungen / Resultados

- 1.
- 2.
- 3.
- 3.
- 5.
- 5.
- 7.
- 7.

Trostrunde / Repechage / Ronda de consolación



3.

3.

POOL A

1	CARRERA SALSAMENDI, Amets	VAS	1	CARRERA SALSAMENDI, Amets
17			17	
9	PARA CASTEJON, Arturo	MUR	2	
25	LOPEZ BEDON, Enrique	MAD	25	
5	CAMEJO LARIOS, Victor	CAN	3	CAMEJO LARIOS, Victor
21			18	
13	IBANEZ PINERO, Alejandro	AND	4	
29	RODRIGUEZ RODRIGUEZ, Nicolas	CTB	29	

POOL A Winner / Ganador
Vainqueur / Sieger

POOL B

3	GONZALEZ BACIGALUPO, Andres	BAL	5	GONZALEZ BACIGALUPO, Andres
19			19	
11	GOMEZ GRACIA, Brian	MAD	6	
27	DUC LOPEZ, Daniel	NAV	27	
7	CHEMLAL HASSAN, Hamza	CAN	7	CHEMLAL HASSAN, Hamza
23			20	
15	FERNANDEZ MONJE, Hugo	AST	8	
31	SALOUM AZGHOUD, Yousef	CAT	31	

POOL B Winner / Ganador
Vainqueur / Sieger

POOL C

2	RUIZ TORRES, David	CAN	9	RUIZ TORRES, David
18			21	
10	LOPEZ CARDENAS, Edgar	AND	10	
26	GARCIA KADRI, Karim	MAD	26	
6	GARCIA ANORBE, Tasio	CLE	11	GARCIA ANORBE, Tasio
22			22	
14	FERNANDEZ GARCIA, Raul	VAL	12	
30	RODRIGUEZ PABLOS, Agustin	EXT	30	

POOL C Winner / Ganador
Vainqueur / Sieger

POOL D

4	VILLANUEVA ASENJO, Hugo	RIO	13	VILLANUEVA ASENJO, Hugo
20			23	
12	SALVADOR MASSO, Oriol	BAL	14	SALVADOR MASSO, Oriol
28			28	
8	PEREZ BECEIRO, Manuel	GAL	15	PEREZ BECEIRO, Manuel
24			24	
16	ROSET, Raul Catalin	ARA	16	
32	ARJONILLA QUINTANA, Manuel	MAD	32	

POOL D Winner / Ganador
Vainqueur / Sieger

1.

43



Results	
Résultat / Platzierungen / Resultados	
1.	
2.	
3.	
4.	
5.	
6.	
7.	

Trostrunde / Repechage / Ronda de consolación

Repechage / Trostrunde / Repechage

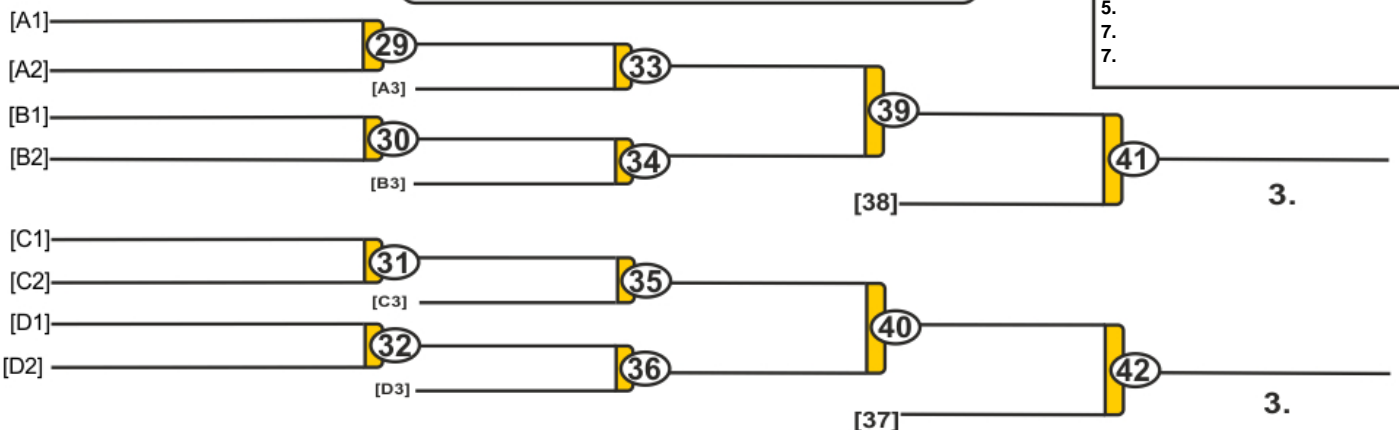

3.

3.

POOL A

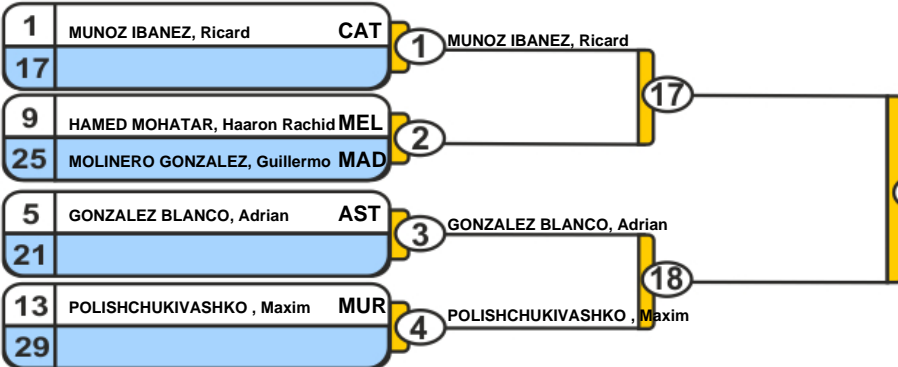

POOL A Winner / Ganador
Vainqueur / Sieger

POOL B

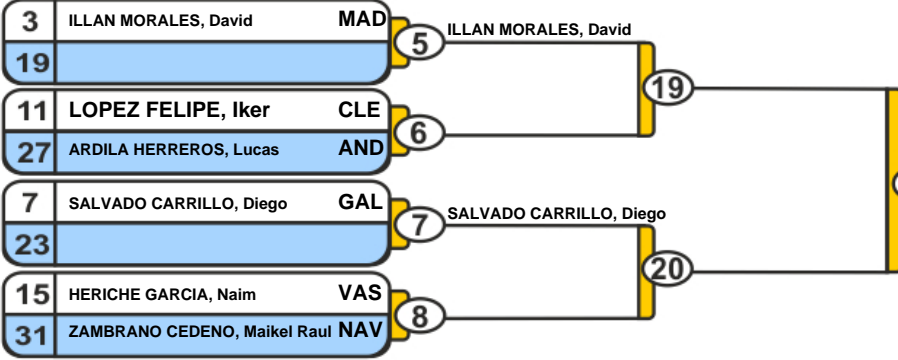

POOL B Winner / Ganador
Vainqueur / Sieger

POOL C

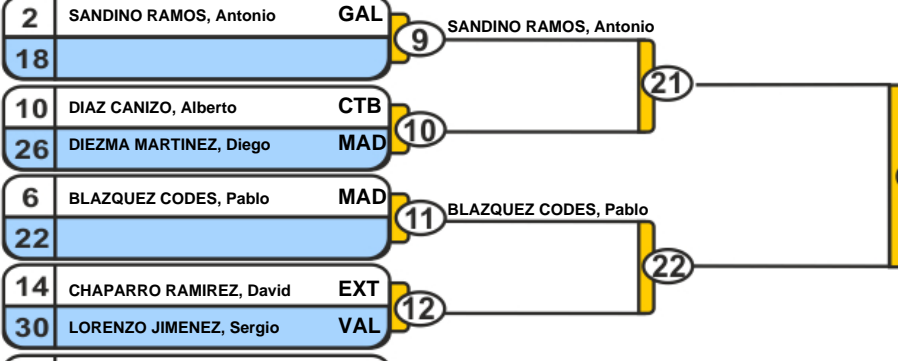

POOL C Winner / Ganador
Vainqueur / Sieger

POOL D

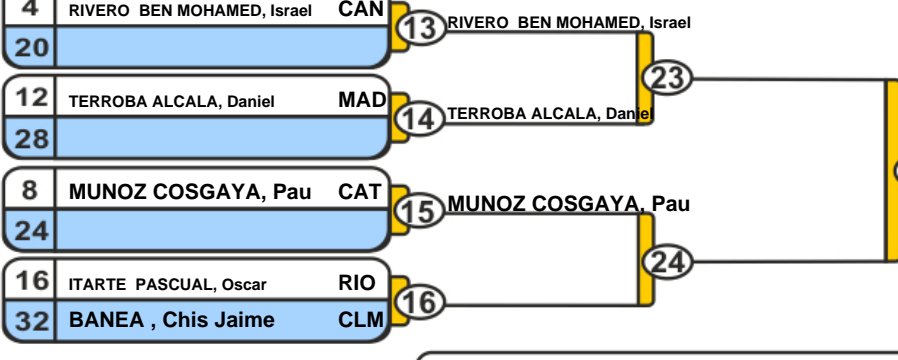

POOL D Winner / Ganador
Vainqueur / Sieger

1.

43



Results	
Résultat / Platzierungen / Resultados	
1.	
2.	
3.	
3.	
5.	
5.	
7.	
7.	

Trostrunde / Repechage / Ronda de consolación

Repechage / Trostrunde / Repechage

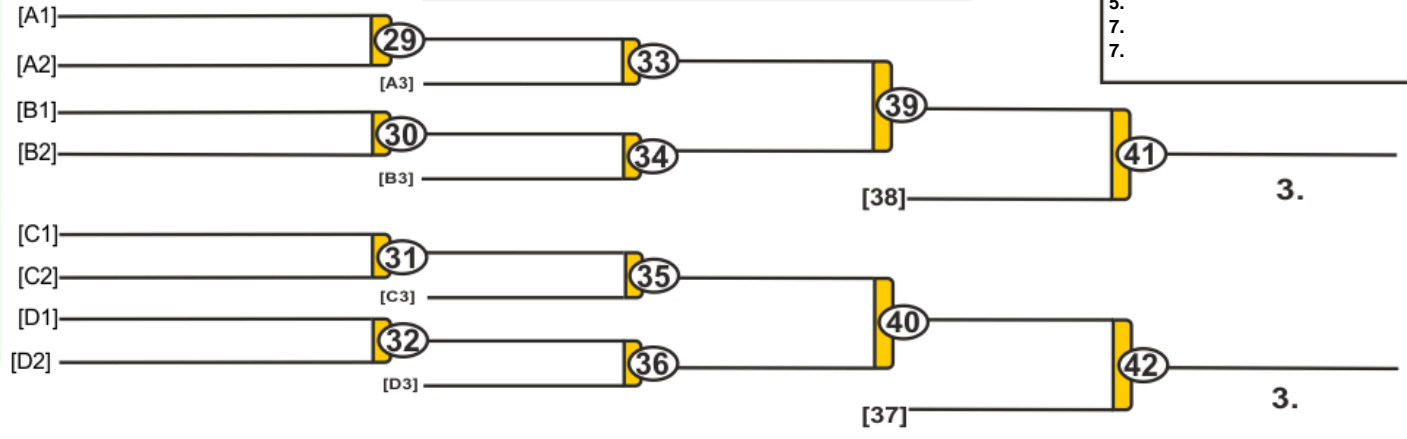

3.

3.

POOL A

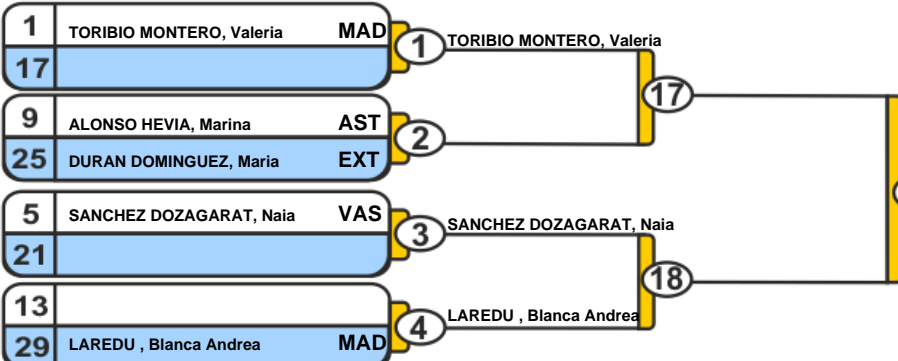

POOL A Winner / Ganador
Vainqueur / Sieger

POOL B

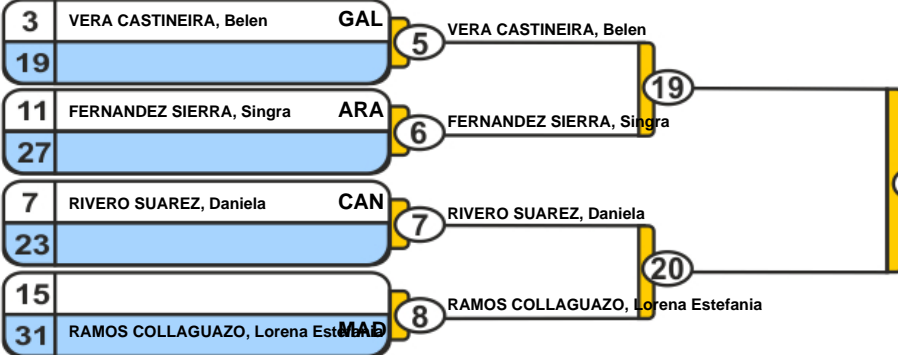

POOL B Winner / Ganador
Vainqueur / Sieger

POOL C

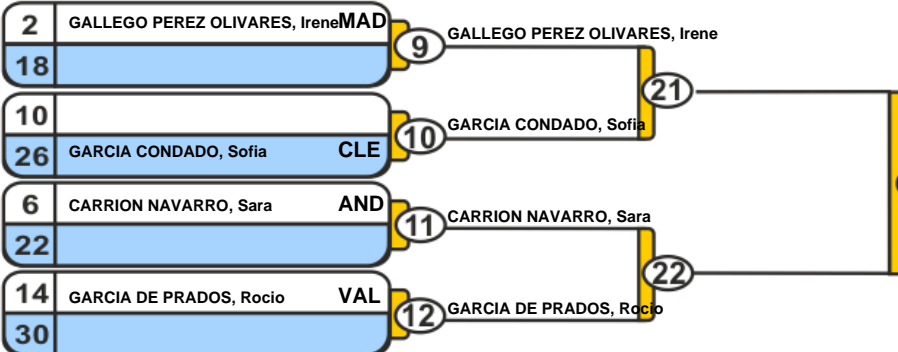

POOL C Winner / Ganador
Vainqueur / Sieger

POOL D

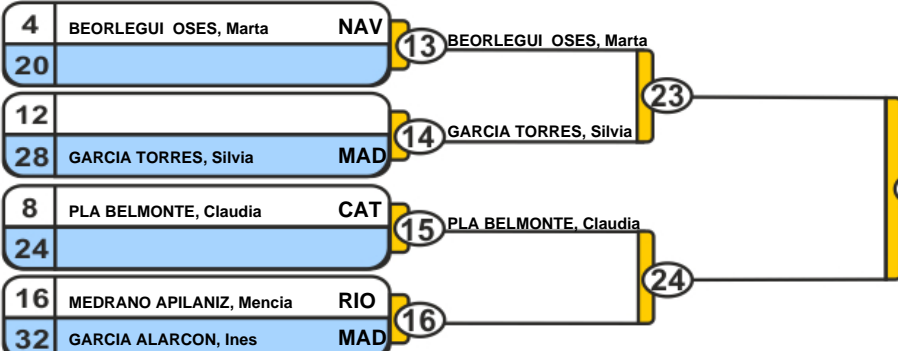

POOL D Winner / Ganador
Vainqueur / Sieger

1.

43



Results	
Résultat / Platzierungen / Resultados	
1.	
2.	
3.	
3.	
5.	
5.	
7.	
7.	

Trostrunde / Repechage / Ronda de consolación

Repechage / Trostrunde / Repechage

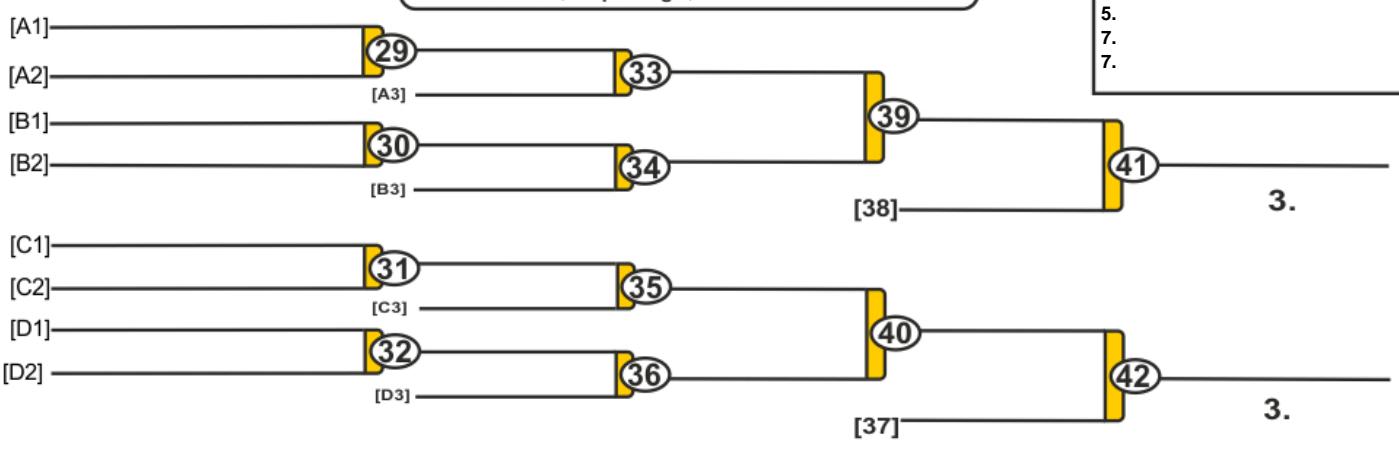

3.

3.

POOL A

1	CABEZUDO NIETO, Adriana	CLE	1	CABEZUDO NIETO, Adriana
17			17	
9	BARINAGA PADURA, Olaia	VAS	2	
25	BLANCO HORTIGUERA PEDRERO, MADA		25	
5	FONTECHA MUNOZ, Celia	CLE	3	
21	FERRANDIS ARNAU, Laia	VAL	18	
13	FERNANDEZ MARQUEZ, Yulema	NAV	4	
29	PALOMINO VALLE, Ines	CLM		

POOL A Winner / Ganador
Vainqueur / Sieger

POOL B

3	SALGUERO CAPELLAN, Soledad	EXT	5	SALGUERO CAPELLAN, Soledad
19			19	
11	SAEZ HEVIA, Adriana	MAD	6	
27	PRALLONG PALACIO, Elena	RIO		
7	MESA FERNANDEZ, Adriana	GAL	7	MESA FERNANDEZ, Adriana
23			20	
15	RODRIGUEZ VICENTE, Marta	CAT	8	
31	RUIZ CORDERA, Celia	AST		

POOL B Winner / Ganador
Vainqueur / Sieger

POOL C

2	MARTINEZ CABRERA, Estrella	AST	9	MARTINEZ CABRERA, Estrella
18			21	
10	PEREZ LOPEZ, Lia	MAD	10	
26	BERNAL GARCIA, Irene	AND		
6	DOMEQUE CLAVERIA, Sofia	ARA	11	
22	MARTINEZ PEREZ, Irene	CLM	22	
14	GONGORA HOKANO, Julia	BAL	12	
30	PEREZ IZQUIERDO, Paola	MUR		

POOL C Winner / Ganador
Vainqueur / Sieger

POOL D

4	DOMINGO BENEDICTO, Lucia	CAT	13	DOMINGO BENEDICTO, Lucia
20			23	
12	ARCONES MONTENEGRO, Maria D	MAD	14	
28	JOELINA WOLP, Wanda	CAN		
8	HERRERA PEREZ, Paula	CTB	15	HERRERA PEREZ, Paula
24			24	
16	SANCHEZ OLIVARES, Nuria	EXT	16	
32	GAITERO MARTIN, Marta	GAL		

POOL D Winner / Ganador
Vainqueur / Sieger

1.

43



Results	
Résultat / Platzierungen / Resultados	
1.	
2.	
3.	
3.	
5.	
5.	
7.	
7.	

Trostrunde / Repechage / Ronda de consolación

Repechage / Trostrunde / Repechage

[A1]	29	33	
[A2]			
[B1]	30	34	39
[B2]			
[C1]	31	35	
[C2]			
[D1]	32	36	40
[D2]			
			41
			42
			38
			37

3.

3.

POOL A

1	DIAZ HERNANDEZ, Aitana	MAD	1	DIAZ HERNANDEZ, Aitana
17			17	
9	LOPEZ RUIZ, Maria Del Carmen	AND	2	
25	ALBA GALAN, Irene	BAL	25	
5	CUERVO CUETO, Nayara	AST	3	
21	PLASENCIA REBOLLO, Ainhoa	CAN	18	
13	GARCIA FRANCO, Andrea	CLE	4	
29	JAUURRIETA ESTENSORO, Uxue	VAS	18	

POOL A Winner / Ganador
Vainqueur / Sieger

POOL B

3	PLOU PORRUA, Lucia	ARA	5	PLOU PORRUA, Lucia
19			19	
11	LOPEZ ELIZALDE, Leire	NAV	6	
27	ALMEIDA TALAVERA, Alba	RIO	26	
7	LYSOGOR CHERKESOVA, Natalia	MAD	7	LYSOGOR CHERKESOVA, Natalia
23			20	
15	MERINO GOMEZ, Celia	CLM	8	
31	BOJ CHAVEZ, Tamara	VAL	20	

POOL B Winner / Ganador
Vainqueur / Sieger

POOL C

2	ALONSO RODRIGUEZ, Andrea	CAN	9	ALONSO RODRIGUEZ, Andrea
18			21	
10	ALTABA MEDRANO, Ines	ARA	10	
26	RUIZ MARIN, Claudia	MAD	27	
6	TELO GARCIA, Lorena	EXT	11	
22	CANALS ROCA, Ingrid	CAT	22	
14	SUAREZ SANCHEZ, Bereket	CTB	12	
30	MARIN BAYO, Lucia	GAL	22	

POOL C Winner / Ganador
Vainqueur / Sieger

POOL D

4	JALON GONZALEZ, Marina	CLE	13	JALON GONZALEZ, Marina
20			23	
12	TOMAS QUIRANT, Julia	VAL	14	
28	GONZALEZ CASTEJON, Nerea	ARA	28	
8	MARTINEZ BARBERO, Alejandra	MAD	15	
24	USERO RUBIO, Alba	MAD	24	
16	GARCIA LOPEZ, Sandra	MUR	16	
32	HADDOU MIMUN, Fatima	MEL	24	

POOL D Winner / Ganador
Vainqueur / Sieger

1.

43



Results	
Résultat / Platzierungen / Resultados	
1.	
2.	
3.	
3.	
5.	
5.	
7.	
7.	

Trostrunde / Repechage / Ronda de consolación

Repechage / Trostrunde / Repechage

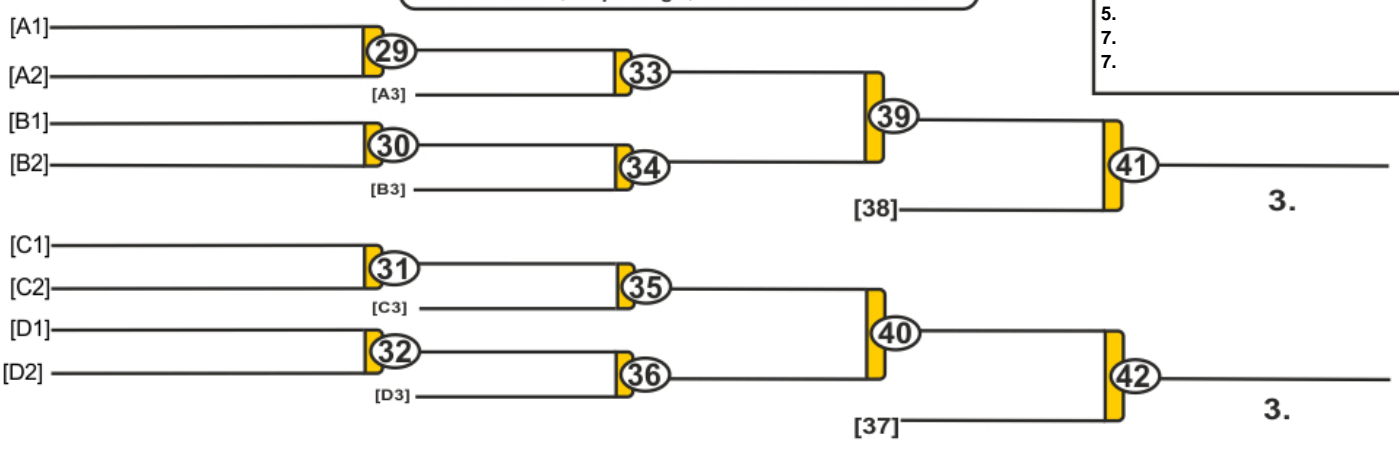

POOL A

1	CASTANO LUNA, Irene	VAL
17		
9	SANCHEZ ZABALA, Julia	MUR
25	RODRIGUEZ QUINTANA, Ane	VAS
5	CRUZ ALT, Vanessa	CAT
21	CANO MARTINEZ, Cristina	MAD
13	CASANOVA BONAFAE, Cora Maria	BAL
29	MARIN BARCINA, Patricia	RIO

1	CASTANO LUNA, Irene
17	
2	
3	
4	

17	
25	
18	

25	POOL A Winner / Ganador Vainqueur / Sieger
----	--

POOL B

3	MURILLO MTNEZ DE LIZARRONDO, Arrate	NAV
19		
11	MANTILLA SERNA, Lucia	CTB
27	HERNANDEZ SUAREZ, Xiomara De	CAN
7	PASTOR GALVEZ, Lucia	MAD
23		
15	GOMEZ IBASETA, Marina	GAL
31	SILVARES FRANCO, Miriam	CLE

5	MURILLO MTNEZ DE LIZARRONDO, Arrate
19	
6	
7	PASTOR GALVEZ, Lucia
20	
8	

19	
20	

26	POOL B Winner / Ganador Vainqueur / Sieger
----	--

POOL C

2	VILLAHOZ MARTINEZ, Ines	GAL
18		
10	ESCALANTE PORRAS, Yaiza	EXT
26	GONZALEZ PUERTOLAS RUIPEREZ, C.M.	CAN
6	VIGUERAS USERO, Alba	CAT
22	GIL SERGIO, Maria Isabel	AND
14	DE VEGA ENCINAS, Maria	MAD
30	CARAZO LACUNZA, Andrea	MAD

9	VILLAHOZ MARTINEZ, Ines
21	
10	
11	
12	

21	
22	

27	POOL C Winner / Ganador Vainqueur / Sieger
----	--

POOL D

4	CASTRO ESTEBAN, Malena	MAD
20		
12	SANCHEZ PIAZUELO, Julia	ARA
28	PEREZ LOPEZ, Elba	NAV
8	GONZALEZ CARABALLO, Estefania	CAN
24		
16	ALIAS ADSUAR, Carla	VAL
32	GARCIA CUESTA, Paula	AST

13	CASTRO ESTEBAN, Malena
23	
14	
15	GONZALEZ CARABALLO, Estefania
24	
16	

23	
24	

28	POOL D Winner / Ganador Vainqueur / Sieger
----	--

1.

43



Results	
Résultat / Platzierungen / Resultados	
1.	
2.	
3.	
3.	
5.	
5.	
7.	
7.	

Trostrunde / Repechage / Ronda de consolación

Repechage

[A1]		29	
[A2]			33
[B1]			
[B2]		30	
			34
[C1]			
[C2]		31	
[D1]			
[D2]		32	
			36

33	
39	
38	
41	
3	
35	
40	
37	
42	
3	

POOL A

1	SEVILLANO FERNANDEZ, Daniela	AST	1	SEVILLANO FERNANDEZ, Daniela
17				17
9	ESCRICHE HERNANDO, Maria	MAD	2	
25	HARINA GARTZIA, June	VAS		25
5	HERNANDO PEREZ, Paula	MUR	3	
21	SISQUELLA NAVARRO, Isabel	CAT		18
13	MARIN MORATO, Marina	AND	4	
29	MANGUT ARIAS, Adriana	EXT		18

POOL A Winner / Ganador
Vainqueur / Sieger

POOL B

3	PEREZ AGUEDA, Alejandra	ARA	5	PEREZ AGUEDA, Alejandra
19				19
11	ALMEIDA HERNANDEZ, Itzel	CAN	6	
27	GONZALEZ PUERTOLAS RUIPEREZ, Claudia	CLM		26
7	MARTINEZ DE RITUERTO MORILLAS, Beatriz	MAD	7	MARTINEZ DE RITUERTO MORILLAS, Beatriz
23				20
15	GOMEZ SILVESTRE, Sandra Xiu	CTB	8	
31	LLOPIS JORDA, Llum	VAL		20

POOL B Winner / Ganador
Vainqueur / Sieger

POOL C

2	ROJO PORQUET, Bruna	CAT	9	ROJO PORQUET, Bruna
18				21
10	SUAREZ GARCIA, Adriana	CAN	10	
26	ALVAREZ PARIENTE, Elena	AST		27
6	PEREZ LIMIA, Ana	GAL	11	
22	SBIROLI SERNA, Sara	VAL		22
14	SANTOS RAMOS, Johrianny Daniel	MAD	12	
30	REYES PALIANI, Nerea	AND		22

POOL C Winner / Ganador
Vainqueur / Sieger

POOL D

4	GARCIA MOYA, Virginia	VAL	13	GARCIA MOYA, Virginia
20				23
12	MARGINEAN, Asyra Stefania	BAL	14	
28	GUTIERREZ GARCIA, Monica	CLE		28
8	BLANCO GARCIA, Naira	GAL	15	BLANCO GARCIA, Naira
24				24
16	GONZALEZ SAN FRUTOS, Paula	MAD	16	
32	BRAHIMI TOUAIBIA, Amina	NAV		24

POOL D Winner / Ganador
Vainqueur / Sieger

1.

43



Results	
Résultat / Platzierungen / Resultados	
1.	
2.	
3.	
3.	
5.	
5.	
7.	
7.	

Trostrunde / Repechage / Ronda de consolación

Repechage / Trostrunde / Repechage

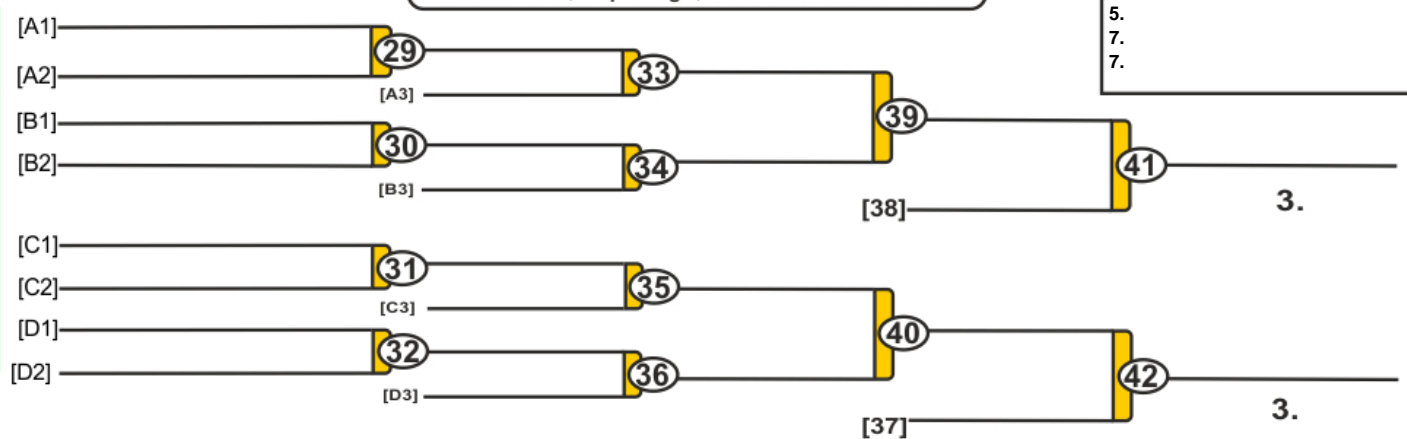

POOL A

1	MARTIN GONZALEZ, Angela	MAD	1	MARTIN GONZALEZ, Angela
17			17	
9	MORENO SERRANO, Ana Marta	CLM	2	
25	RODRIGUEZ CAMUS, Mar	CTB	25	
5	IGLESIAS DE LOS RIOS, Zoe	CAT	3	
21	ALONSO LOPEZ, Larraitz	VAS	18	
13	GARCIA SOLERA, Natalia	MAD	4	
29	SANTOS PINERA, Ana	AST	18	

POOL A Winner / Ganador
Vainqueur / Sieger

POOL B

3	PEREZ BANEZ, Paula	AND	5	PEREZ BANEZ, Paula
19			19	
11	ALBITOS LOPEZ, Carla	MAD	6	
27	CARDONA DAZA, Alexandra Guada	BA	26	
7	CEJAS MACHIN, Amelia	CAN	7	CEJAS MACHIN, Amelia
23			20	
15	GUAL MONFORT, Mireia	VAL	8	
31	PAZOS TRILLO, Lucia	GAL	20	

POOL B Winner / Ganador
Vainqueur / Sieger

POOL C

2	PEREZ GARCIA, Alejandra	AST	9	PEREZ GARCIA, Alejandra
18			21	
10	DE JUAN SAN SEGUNDO, Angela	CLE	10	
26	MARTOS GARCIA, Raquel	MAD	27	
6	PERALTA BEJAR, Marina	CAT	11	PERALTA BEJAR, Marina
22			22	
14	MARTINEZ MARTINEZ, Aitana	RIO	12	
30	CHIRLAQUE, Ines	MUR	22	

POOL C Winner / Ganador
Vainqueur / Sieger

POOL D

4	CASTELLANOS PASTOR, Candela	AST	13	CASTELLANOS PASTOR, Candela
20			23	
12	SOS SAN JULIAN, Adriana	NAV	14	
28	MARTINEZ SAEZ, Neila	EXT	28	
8	PEREZ MUR, Candela	ARA	15	PEREZ MUR, Candela
24			24	
16	HERNANDEZ ARIAS, Raquel	GAL	16	
32	PEDROCHE SANCHEZ, Sara	MAD	24	

POOL D Winner / Ganador
Vainqueur / Sieger

1.

43



Results

Résultat / Platzierungen / Resultados

1.
2.
3.
3.
5.
5.
7.
7.

Trostrunde / Repechage / Ronda de consolación

Repechage / Trostrunde / Repechage

[A1]	29	33		
[A2]				
[B1]		[A3]	39	
[B2]	30	34		41
		[B3]		[38]
[C1]				
[C2]	31	35		
[D1]		[C3]		
[D2]	32	36		42
		[D3]		[37]

3.

3.

POOL A

1	SANCHEZ DELGADO, Alba	ARA	1	SANCHEZ DELGADO, Alba
17			17	
9	LOPEZ MANZANO, Estefania	CLE	2	
25	REGADES ACIEN, Noa	AND	2	
5	LLOBET FRIGOLS, Berta	CAT	3	
21	MARIN NUNEZ, Natalia	EXT	3	
13	URRUTIA MADDOZ, Anne	NAV	4	
29	ROMERO ALVARO, Ana	MAD	4	

POOL A Winner / Ganador
Vainqueur / Sieger

POOL B

3	DANCHEVA , Aleksia Emiliyanova	MAD	5	DANCHEVA , Aleksia Emiliyanova
19			19	
11	FUENTES AFONSO, Rocio	GAL	6	
27	RAMOS RUIZ, Alba	RIO	6	
7	PERIGUELL GARCIA, Aitana	VAL	7	PERIGUELL GARCIA, Aitana
23			20	
15	MORAN QUIJANO, Marta	CTB	8	
31	FERNANDEZ ESPANA, Maravillas	MUR	8	

POOL B Winner / Ganador
Vainqueur / Sieger

POOL C

2	ALDEGUER MONTES, Lucia	VAL	9	ALDEGUER MONTES, Lucia
18			21	
10	QUERALT GARCIA, Daria	CAT	10	
26	REYES SOSA, Leanna Victoria	VAS	10	
6	PARDO ORTEGA, Tania	VAL	11	PARDO ORTEGA, Tania
22			22	
14	GARCIA CANO, Marina	CLM	12	
30	GIRALDA CUBAS, Paola	MAD	12	

POOL C Winner / Ganador
Vainqueur / Sieger

POOL D

4	IKEME MASCARO, Ogonna	BAL	13	IKEME MASCARO, Ogonna
20			23	
12	SANCHEZ PERBECH, Julia	ARA	14	
28	MOSQUERA TRAPERO, Paula	MAD	14	
8	HERNANDEZ LEON, Paula	CAN	15	HERNANDEZ LEON, Paula
24			24	
16	MARTINEZ MEDIO, Belen	AST	16	
32	ALVAREZ SOLTERO, Claudia	AND	16	

POOL D Winner / Ganador
Vainqueur / Sieger

1.

43



Results	
Résultat / Platzierungen / Resultados	
1.	
2.	
3.	
3.	
5.	
5.	
7.	
7.	

Trostrunde / Repechage / Ronda de consolación

Repechage / Trostrunde / Repechage

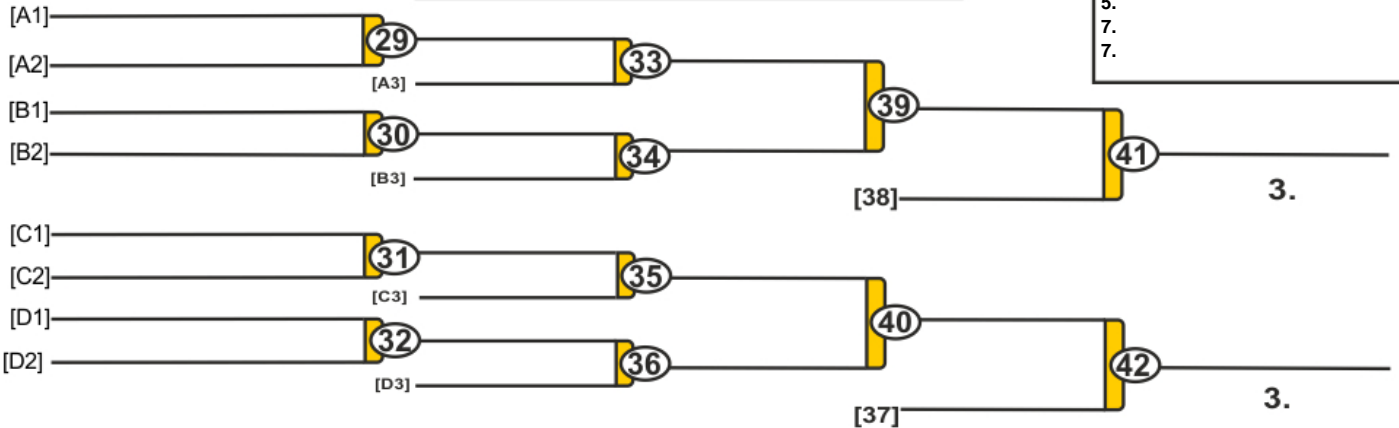

POOL A

1	HIJARRUBIA GONZALEZ, Sofia	CLE	1	HIJARRUBIA GONZALEZ, Sofia
17			17	
9	PLASENCIA MORA, Raissa	VAL	2	
25	CABANAS DIAZ, Cristina	MAD	25	
5	NARRO MARTINEZ, Oria	RIO	3	
21	IGLESIAS MARTIN, Blanca	MAD	18	
13	MUNOZ DE LA TORRE CALVO, Alic	GLM	4	
29	TANAKA ANGULO, Kaori	CAN	4	

POOL A Winner / Ganador
Vainqueur / Sieger

POOL B

3	RODRIGUEZ LARGO, Cristina	MAD	5	RODRIGUEZ LARGO, Cristina
19			19	
11	MARIN , Alejandra Beatriz	AND	6	
27	AUSTING GARATE, Lore	VAS	6	
7	RIVEIRO BECERRA, Lucia	GAL	7	RIVEIRO BECERRA, Lucia
23			20	
15	ROMAN RODRIGUEZ, Lucia	AST	8	
31	GARCIA LARDIN, Delia	MUR	8	

POOL B Winner / Ganador
Vainqueur / Sieger

POOL C

2	SALA CANO, Aitana	VAL	9	SALA CANO, Aitana
18			21	
10	PENA MORON, Cristina	CLE	10	
26	ASENSIO PRATS, Ada	BAL	10	
6	VAZQUEZ MERENCIANO, Julia	CAT	11	VAZQUEZ MERENCIANO, Julia
22			22	
14	MINCIUNA , Desire	MAD	12	
30	SANCHEZ SANCHEZ, Maria	EXT	12	

POOL C Winner / Ganador
Vainqueur / Sieger

POOL D

4	TRUJILLO MENDEZ, Aisha	CAN	13	TRUJILLO MENDEZ, Aisha
20			23	
12	ESCALADA DE DIEGO, Maria	NAV	14	
28	VICO RODRIGUEZ, Carla	MAD	14	
8	GONZALEZ LORIENTE, Laura	ARA	15	GONZALEZ LORIENTE, Laura
24			24	
16	PEREZ SAIZ, Claudia	CTB	16	
32	BEJARANO VALLADOLID, Teresa	AND	16	

POOL D Winner / Ganador
Vainqueur / Sieger

1.

43



38

Results

Résultat / Platzierungen / Resultados

1.
2.
3.
3.
5.
5.
7.
7.

Trostrunde / Repechage / Ronda de consolación

Repechage / Trostrunde / Repechage

[A1]	29	33	
[A2]			
[B1]	30	34	39
[B2]			
[C1]	31	35	
[C2]			
[D1]	32	36	40
[D2]			
[A3]			
[B3]			41
[C3]			
[D3]			42
			38
			37

3.

3.

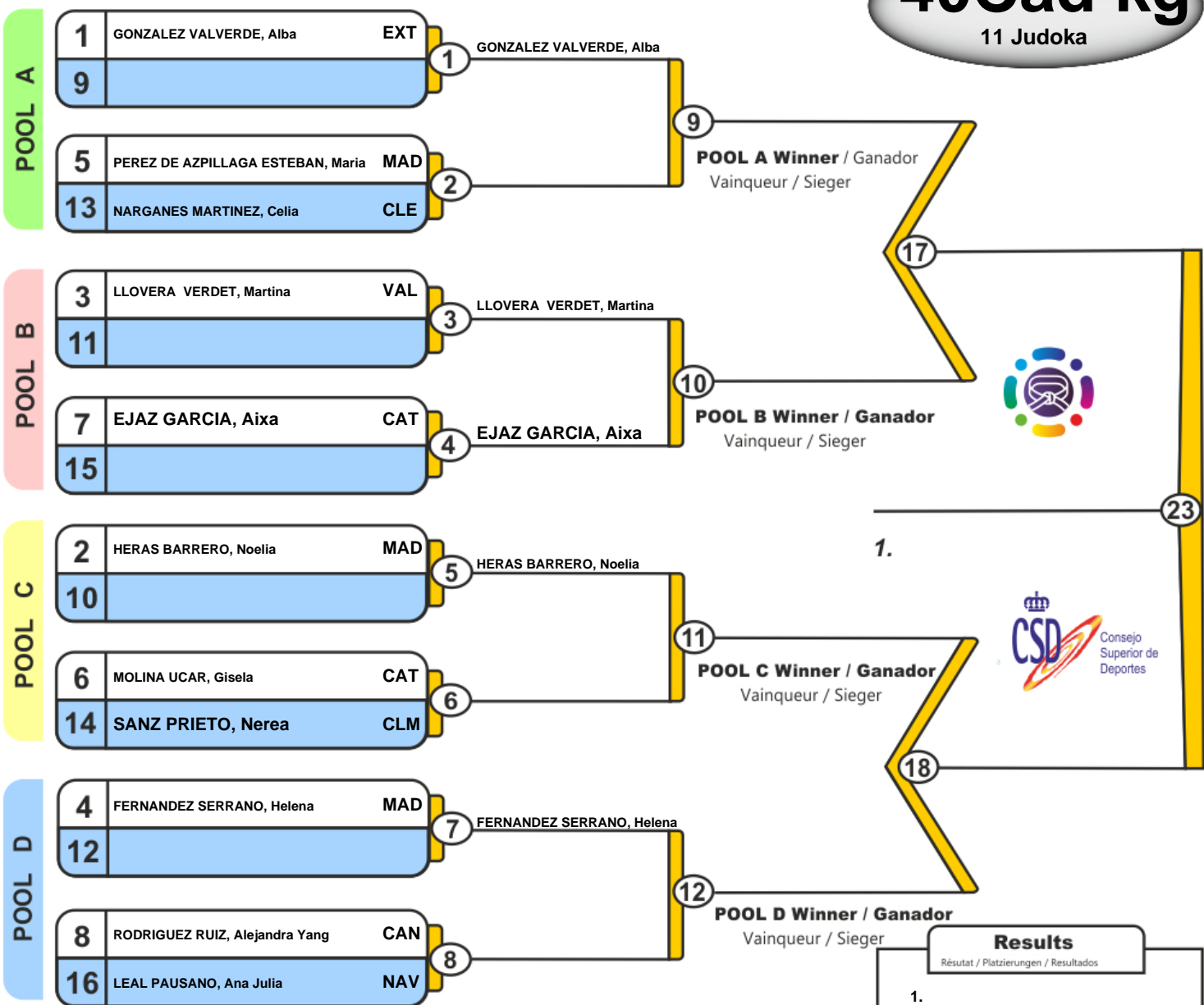

Trostrunde / Repechage / Ronda de consolación

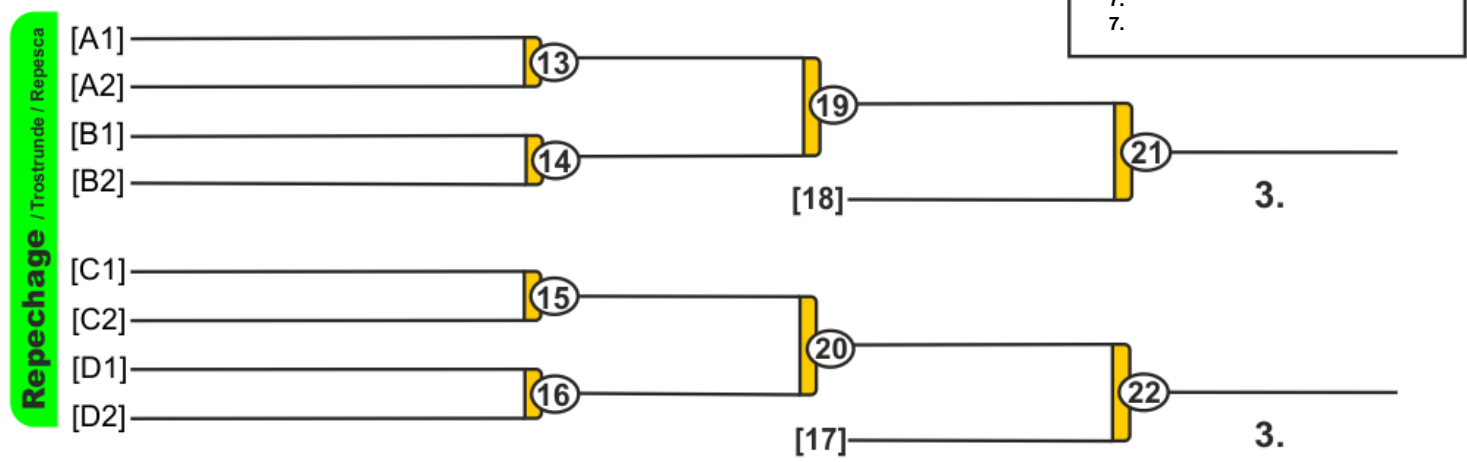

Results	
Rèultat / Platzierungen / Resultados	
1.	
2.	
3.	
3.	
5.	
7.	
7.	

POOL A

1	ROJAS GONZALEZ, Maria	GAL	1	ROJAS GONZALEZ, Maria
17			17	
9			2	RIBEIRO CHACON, Laura
25	RIBEIRO CHACON, Laura	MAD	25	
5	ROVIRA LEON, Silvia	VAL	3	ROVIRA LEON, Silvia
21			18	
13			4	CID BALCELLS, Paula
29	CID BALCELLS, Paula	CAT	29	

POOL A Winner / Ganador
Vainqueur / Sieger

POOL B

3	MATEOS GARCIA, Carla	CLE	5	MATEOS GARCIA, Carla
19			19	
11	MARTINELLI SOBERON, Izaskun	NAV	6	MARTINELLI SOBERON, Izaskun
27			20	
7	NUNO DE LA ROSA CENTENO, Mar	MAD	7	NUNO DE LA ROSA CENTENO, Marta
23			20	
15	NIETO FORESTI, Sofia	BAL	8	
31	LOPEZ LLORENTE, Mainer Liduan	VAS	31	

POOL B Winner / Ganador
Vainqueur / Sieger

POOL C

2	FERREIRO CABADO, Belen	GAL	9	FERREIRO CABADO, Belen
18			21	
10	HERNANDEZ FLORES, Nayara	AND	10	HERNANDEZ FLORES, Nayara
26			22	
6	ROMEU ROLDAN, Raquel	CAT	11	ROMEU ROLDAN, Raquel
22			22	
14			12	SILES HERNANDEZ, Lucia
30	SILES HERNANDEZ, Lucia	MAD	30	

POOL C Winner / Ganador
Vainqueur / Sieger

POOL D

4	PEREZ SOLER, Eva	MAD	13	PEREZ SOLER, Eva
20			23	
12			14	SICILIA GARCIA, Ainhoa
28	SICILIA GARCIA, Ainhoa	MUR	28	
8	GUTIERREZ MIRANDA, Lian Irina	CAN	15	GUTIERREZ MIRANDA, Lian Irina
24			24	
16			16	SANCHEZ GUTIERREZ, Daniela
32	SANCHEZ GUTIERREZ, Daniela	MAD	32	

POOL D Winner / Ganador
Vainqueur / Sieger

1.

43



Results	
Résultat / Platzierungen / Resultados	
1.	
2.	
3.	
3.	
5.	
5.	
7.	
7.	

Trostrunde / Repechage / Ronda de consolación

Repechage / Trostrunde / Repechage

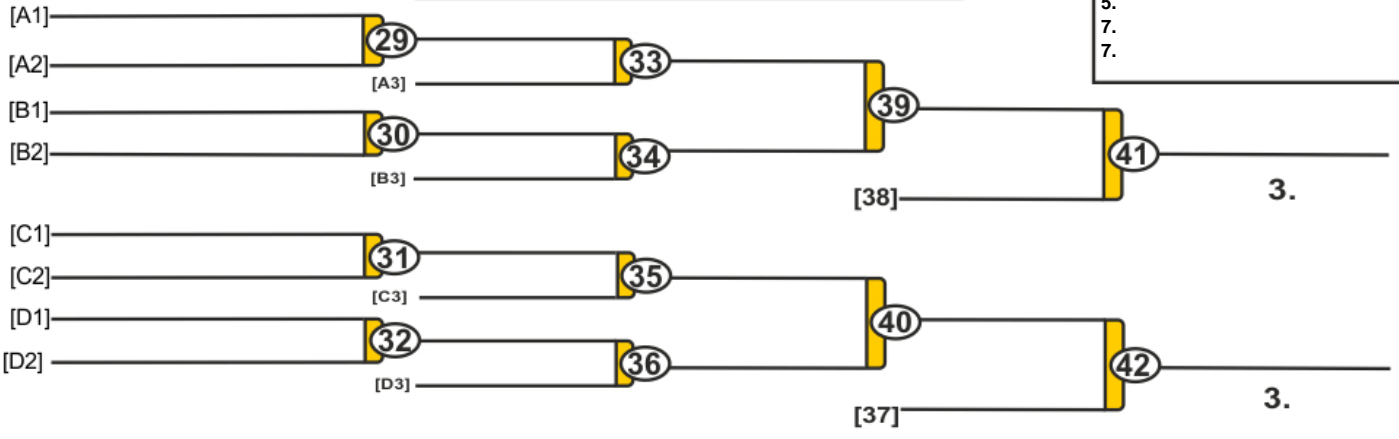

POOL A

1	GOMEZ ANTONA, Gema Maria	MAD	1	GOMEZ ANTONA, Gema Maria
17			17	
9	MANGUT ARIAS, Jimena	EXT	2	
25	REQUE JUNCO, Claudia	CLE	25	
5	CIMA FERNANDEZ, Paula	AST	3	
21	TARAZONA RODRIGO, Marta	VAL	18	
13	CULEA CULEA, Alexandra	CAT	4	
29	MORIN DIAZ, Lucia	CAN	18	

POOL A Winner / Ganador
Vainqueur / Sieger

POOL B

3	BULDAIN ELIZALDE, Joane	ARA	5	BULDAIN ELIZALDE, Joane
19			19	
11	LARA VIDAURRAZAGA, Noa	RIO	6	
27	GOYAL, Khushi	AND	20	
7	ARREGI MIGUEL, Ane Miren	VAS	7	
23	MANSILLA TORRES, Monica	BAL	20	
15	MEDEL MARCOS, Luna	MAD	8	
31	DURAN LUSTRES, Lia	GAL	20	

POOL B Winner / Ganador
Vainqueur / Sieger

POOL C

2	FALCON SANCHEZ, Zuleima	CAN	9	FALCON SANCHEZ, Zuleima
18			21	
10	MURILLO BALDOMINOS, Maria	ARA	10	
26	BONILLA COBO, Andrea	CTB	22	
6	ALVAREZ FERNANDEZ, Carlota	AST	11	
22	DOMINGO AYALA, Clara	AND	22	
14	REIS RODRIGUES PALHAS EZEQUIAS, Constanza	MAD	12	
30	MEDICES VEGA, Delia	VAS	22	

POOL C Winner / Ganador
Vainqueur / Sieger

POOL D

4	FERNANDEZ SANCHEZ, Elisa	AST	13	FERNANDEZ SANCHEZ, Elisa
20			23	
12	MERINO GOMEZ, Alba	CLM	14	
28	ARNEDO EZQUERRO, Lucia	NAV	24	
8	JARDO MARTIN, Noelia	CAT	15	
24	SANZ MARTIN, Amanda	MAD	24	
16	GONZALEZ MACHADO, Alba	GAL	16	
32	MARTINEZ SUAREZ, Maria	BAL	24	

POOL D Winner / Ganador
Vainqueur / Sieger

1.

43



Results

Résultat / Platzierungen / Resultados

1.
2.
3.
3.
5.
5.
7.
7.

Trostrunde / Repechage / Ronda de consolación

Repechage / Trostrunde / Repechage

[A1]	29	33	
[A2]			
[B1]	30	34	39
[B2]			
[C1]	31	35	[38]
[C2]			
[D1]	32	36	40
[D2]			
			[37]

3.

3.

POOL A

1	TORO SOLER, Ariane	AST	1	TORO SOLER, Ariane
17			17	
9	GUTIERREZ CABEZON, Nuria	RIO	2	
25	DIAZ DE HARO, Julia Ye	AND	25	
5	PREGONAS SILVESTRE, Naia	VAL	3	
21	FONTECHA MUNOZ, Olga	CLE	18	
13	ALBORNOZ GONZALEZ, Sofia	CAN	4	
29	MORALES VALLES, Marta	MAD	25	

POOL A Winner / Ganador
Vainqueur / Sieger

POOL B

3	PEREZ PACHECO, Veronica	GAL	5	
19	ANDRES FERNANDEZ, Xiomara	CAN	19	
11	ESPARZA RIVERA, Rebeca	MAD	6	
27	PEREZ SOLER, Laura	BAL	20	
7	KONARE SISSOKO, Deniba	VAS	7	
23	GARRIDO RUBIALES, Esther	EXT	26	
15	SANCHEZ SANCHEZ, Maria Del Pilar	MUR	8	
31	VILLEGAS SANTOS, Patricia	MAD	20	

POOL B Winner / Ganador
Vainqueur / Sieger

POOL C

2	CASTELLO DIEZ, Marina	VAL	9	
18	MARTIN DIGIUNI, Lucia Ariana	CAN	21	
10	MANZANERO RUIZ, Maria	MAD	10	
26	BUSTILLO BUSTOS, Alejandra	GAL	22	
6	RAMIREZ GIMENEZ, Alba	ARA	11	
22	GONZALEZ GARCIA, Laura	CTB	22	
14	PENAFIEL INGA, Ainhoa	MUR	12	
30	CASTILLEJOS CASTANO, Gema	CLM	27	

POOL C Winner / Ganador
Vainqueur / Sieger

POOL D

4	BEORLEGUI OSES, Paula	NAV	13	
20	DRUMMOND DEEVES, Mati	CAN	23	
12	FERNANDEZ SANCHEZ, Paula	AND	14	
28	GARCIA PELLICER, Maria	VAL	28	
8	GOMEZ ANTONA, Laura	MAD	15	
24	LORA RODRIGUEZ, Claudia	AST	24	
16	ROMERO GUTIERREZ, Irene	CAT	16	
32	PEREZ DE ARENAZA SAMANIEGO, Ana	VAS	24	

POOL D Winner / Ganador
Vainqueur / Sieger

1.

43



38

Results

Résultat / Platzierungen / Resultados

1.
2.
3.
4.
5.
6.
7.

Trostrunde / Repechage / Ronda de consolación

Repechage / Trostrunde / Repechage

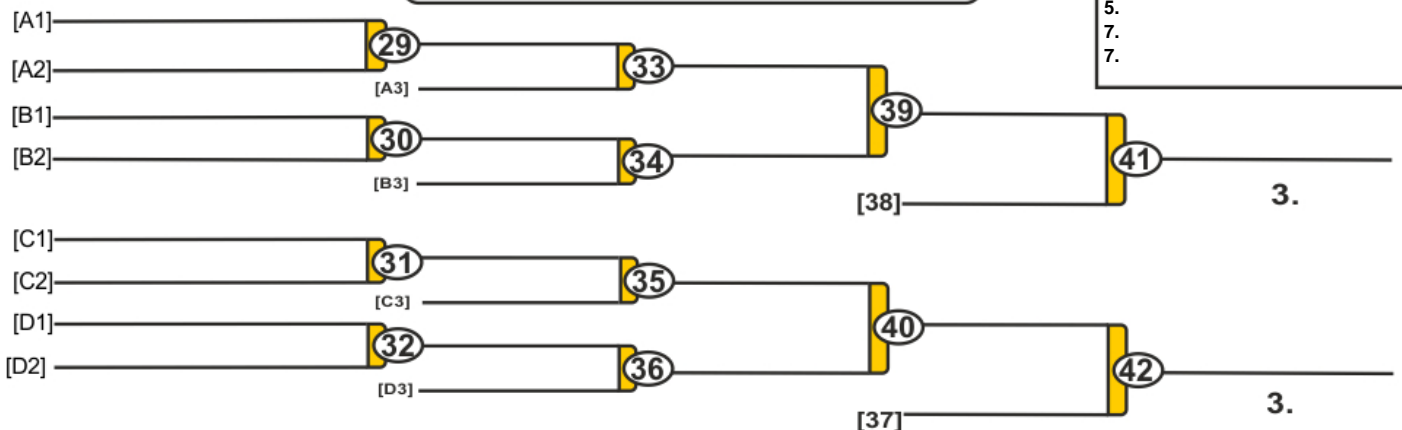

3.

3.

POOL A

1	DIAZ ONEGA, Maria	AST	1	DIAZ ONEGA, Maria
17			17	
9	MOLINA GRANDE, Miriam	MAD	2	
25	ROMERO GONZALEZ, Nerea	GAL	2	
5	MARTIN DE PIEDAD, Martina	CAN	3	
21	SANTIAGO GARCIA, Laura	CTB	3	
13	ROBERT TORRENT, Edith Catalina	BAL	4	
29	SANCHEZ ARRASTIA, Lucia	NAV	4	

POOL A Winner / Ganador
Vainqueur / Sieger

POOL B

3	QUERALTO RAMOS, Julia	CAT	5	QUERALTO RAMOS, Julia
19			19	
11	MARTIN CORREA, Lucia	MUR	6	
27	ROSA CANO, Noelia Ana	VAL	6	
7	NIETO BOILLOS, Luna	ARA	7	
23	OSTO MENA, Lucia	AND	7	
15	JUAN MARTINEZ, Paula	MAD	8	
31	RUIZ IBEAS, Ainhoa	CLE	8	

POOL B Winner / Ganador
Vainqueur / Sieger

POOL C

2	GARCIA MARTIN, Marta	MAD	9	GARCIA MARTIN, Marta
18			21	
10	SANTACREU GARCIA, Neus	CAT	10	
26	ZARCO PEINADO, Irene	CLM	10	
6	MARTINEZ OCHOA, Carmen	RIO	11	
22	MARTINEZ DE RITUERTO MORILLAS, M. De	MAD	11	
14	ALDABALDETREKU ALBERDI, Irene	VAS	12	
30	BALLESTEROS SAIZ, Noelia	VAL	12	

POOL C Winner / Ganador
Vainqueur / Sieger

POOL D

4	RODRIGUEZ SALVADOR, Adriana	VAL	13	RODRIGUEZ SALVADOR, Adriana
20			23	
12	RAMON VELAZCO, Bianka	CAT	14	
28	PUYO AYESA, Ainhoa	NAV	14	
8	MORENO DE LA LLAVE, Maria	MAD	15	
24	LAGE RIVERA, Sabela	GAL	15	
16	GARCIA CORRAL, Celia	EXT	16	
32	CASANUEVA GARCIA, Laura	AND	16	

POOL D Winner / Ganador
Vainqueur / Sieger

1.

43



Results

Résultat / Platzierungen / Resultados

1.
2.
3.
3.
5.
5.
7.
7.

Trostrunde / Repechage / Ronda de consolación

Repechage / Trostrunde / Repechage

[A1]	29	[A2]	33	[A3]		
[B1]	30	[B2]	34	[B3]		39
[C1]	31	[C2]	35	[C3]		38
[D1]	32	[D2]	36	[D3]		40
						41
						42

3.

3.

POOL A

1	FERNANDEZ HERRERA, Aitana	VAL	1	FERNANDEZ HERRERA, Aitana
17				17
9	VEIGA HERNANDEZ, Malena	CAN	2	
25	GONZALEZ DA COSTA EVANGELISA, Ainoa	CAN		25
5	GARCIA ROCO BELO, Katerina	CLM	3	
21	MARTIN SAYAGO, Lara	MAD		18
13	RIVERA PEREZ, Laura	ARA	4	
29	DUBLAN ZUBIETA, Ainhoa	NAV		18

POOL A Winner / Ganador
Vainqueur / Sieger

POOL B

3	SALAZAR RAMOS, Ainoa	CAN	5	
19	ESTRELLA VILLAESCUSA, Lucia	MUR		19
11	JARDON PIQUERO, Lucia	AST	6	
27	CARPIO FERNANDEZ, Paula	MAD		19
7	PEREZ COLLAZO, Eva	RIO	7	
23	LOPEZ DORIGA TAMARGO, Lucia	CTB		20
15	SAIZ SERNA, Ines	CLE	8	
31	LOPEZ SEOANE, Sara	GAL		20

POOL B Winner / Ganador
Vainqueur / Sieger

POOL C

2	VAZQUEZ FERNANDEZ, Laura	GAL	9	
18	SOLBES CONDADO, Marta	VAL		21
10	GONZALEZ GALEANO, Monica	EXT	10	
26	HIDALGO CLAUSIN, Marina	CAT		21
6	RIVEIRO MOURINO, Malena	GAL	11	
22	LERTXUNDI SERRANO, Loraine	VAS		22
14	ZAERA LAMARCA, Lucia	ARA	12	
30	LEON ANDRINO, Estibaliz	MAD		22

POOL C Winner / Ganador
Vainqueur / Sieger

POOL D

4	RONCAL UZQUEDA, Leyre	NAV	13	
20	UJAJUE ROBLES, Miriam	AND		23
12	DOMINGUEZ RODRIGO, Lucia	MAD	14	
28	SERAFIN RODRIGUEZ, Leticia	CAN		23
8	BARREIRO GONZALEZ, Alba	AST	15	
24	TORRES LUMBRERAS, Valeria	VAL		24
16	PRATS RIBAS, Selena	BAL	16	
32	MERINO ROMERA, Berta	CLM		24

POOL D Winner / Ganador
Vainqueur / Sieger

1.

43



Results	
Résultat / Platzierungen / Resultados	
1.	
2.	
3.	
3.	
5.	
5.	
7.	
7.	

Trostrunde / Repechage / Ronda de consolación

Repechage / Trostrunde / Repêchage

[A1]	29	[A2]	33	
[B1]	30	[B2]	34	39
[C1]	31	[C2]	35	[38]
[D1]	32	[D2]	36	40
				41
				42
				3.
				3.

POOL A

1	TSUNODA ROUSTANT, Ai	CAT
17		
9	SANTIAGO HERNANDEZ, Laura	CLM
25	BARRAGANS MARTINEZ, Sofia	AST
5	GARCIA SOLER, Nerea	CAT
21	COBOS LOPEZ, Miriam	MAD
13	VOLO MACHIN, Laura	CAN
29	POKROVSKAIA , Anastasia	RIO

1 TSUNODA ROUSTANT, Ai

2

3

4

POOL B

3	ETXEBARRIA BILBAO, Eunate	VAS
19		
11	VIZOSO HERNANDEZ, Ana	MAD
27	ECHECONANEA SAIZAR, Lorea	NAV
7	DIEZ RODRIGUEZ, Janire	VAS
23	DOMINGUEZ BARREIRO, Xulia	GAL
15	FERNANDEZ SCHMUTZ, Paula	AND
31	MIRET LOPEZ, Raquel	ARA

5 ETXEBARRIA BILBAO, Eunate

6

7

8

POOL C

2	GONZALEZ DOMINGUEZ, Yaylen	CAN
18		
10	MARTIN ESPIGARES, Sherezade	EXT
26	PELAYO CALLEJA, Iria	CTB
6	INSUA IGLESIAS, Noelia	GAL
22	HAUPT , Mila	MAD
14	NICOLAS NICOLAS, Ainhoa	MUR
30	IGLESIAS DE LUCAS, Sara	CLE

9 GONZALEZ DOMINGUEZ, Yaylen

10

11

12

POOL D

4	RAMIREZ VICTORIA, Amparo	VAL
20		
12	POURZAND SAMOJEDEN, Soraya	MAD
28	SALA MOLINA, Marta	BAL
8	KALYNCHUK , Maria	VAL
24	FERNANDEZ DIAZ, Noa	AST
16	ESPIE BASURKO, Nora	VAS
32	PINA GALLARDO, Candela	AND

13 RAMIREZ VICTORIA, Amparo

14

15

16

1.

43

POOL A Winner / Ganador
Vainqueur / Sieger

POOL B Winner / Ganador
Vainqueur / Sieger

POOL C Winner / Ganador
Vainqueur / Sieger

POOL D Winner / Ganador
Vainqueur / Sieger



Results

Résultat / Platzierungen / Resultados

1.
2.
3.
3.
5.
5.
7.
7.

Trostrunde / Repechage / Ronda de consolación

Repechage / Trostrunde / Repechage

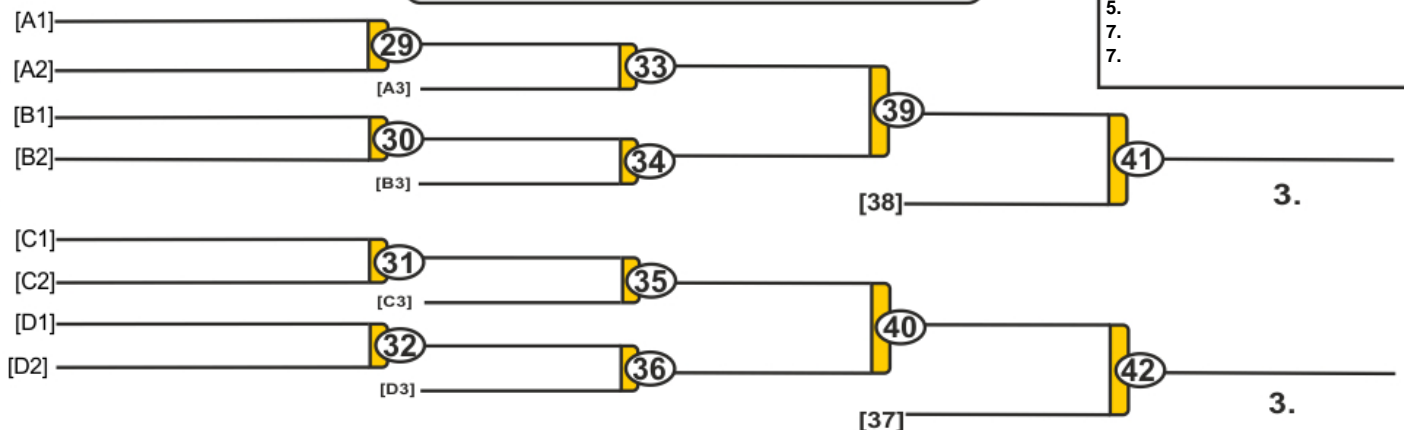

POOL A

1	HEREDIA REYES, Maria Jose	MAD
17		
9	LOPEZ COLLADO, Maria	AST
25	BELLO PALOMO, Alba	GAL
5	SUGRANES PAMIES, Carla	CAT
21		
13	MARIN COMTE, Marina	MUR
29	MARIN BERDONCES, Adela	NAV

1 HEREDIA REYES, Maria Jose

17

2

3 SUGRANES PAMIES, Carla

18

4

POOL B

3	SORIANO MORON, Zoe	AND
19		
11	ORTEGA VICTORIA, Patricia	MAD
27		
7	ESCOLAR GARCIA, Aiala	VAS
23		
15	PACHECO PUENTE, Beatriz	VAL
31	PEREZ CEBRINO, Mar	EXT

5 SORIANO MORON, Zoe

19

6 ORTEGA VICTORIA, Patricia

7 ESCOLAR GARCIA, Aiala

20

8

POOL C

2	LOPEZ CENTENO, Nayade	VAS
18		
10	RULLAN MANES, Aina	BAL
26	HERRERA REYES, Ainhoa	MAD
6	CASTILLO GIL, Carolina	MAD
22		
14	GONZALEZ GARCIA, Arantxa	CLM
30	OLIVEROS CASTRO, Luna	CLE

9 LOPEZ CENTENO, Nayade

21

10 RULLAN MANES, Aina

11 CASTILLO GIL, Carolina

22

12

POOL D

4	ALMENARA BETANCOR, Getsemar	CAN
20		
12	SANCHEZ COBO, Andrea	CTB
28	GUTIERREZ GARCIA, Nerea	MEL
8	PEREA MANZANO, Maria	AND
24		
16		
32	LOSILLA ARCE, Maria	MAD

13 ALMENARA BETANCOR, Getsemani

23

14 GUTIERREZ GARCIA, Nerea

15 PEREA MANZANO, Maria

24

16

16 LOSILLA ARCE, Maria

1.

43

POOL C Winner / Ganador
Vainqueur / Sieger

38

POOL D Winner / Ganador
Vainqueur / Sieger

Results

Résultat / Platzierungen / Resultados

1.
2.
3.
3.
5.
5.
7.
7.

Trostrunde / Repechage / Ronda de consolación

Repechage / Trostrunde / Repechage

[A1]		29		33
[A2]			[A3]	
[B1]		30		34
[B2]			[B3]	
[C1]		31		35
[C2]			[C3]	
[D1]		32		36
[D2]			[D3]	

[38]

3.

[37]

3.